

the leader



APRIL 1994

VOLUME 24, NO. 8

Things for Spring

TREES FOR
CANADA
CONTEST!

DERBY DAY • BEAUTIFUL BIRDS

Raise the Flag!

by Garth Johnson



Photo: Wayne Bennett

Flags are an important part of our Scouting tradition. We raise Group, Section, and national flags at most ceremonies and celebrations. This tradition honours our roots and shows that Canadian Scouting is special, alive and well.

Saturday, May 14, 1994 is *Raise the Flag Day* across Canada. Scouting partners, the Kinsmen & Kinette Clubs of Canada, initiated this day as a chance for all Canadians to express their feelings about Canada in a fun way using the flag as a proud symbol of the rights and freedoms we enjoy as Canadians. Many countries in troubled parts of the world have little to celebrate. Raising our Canadian flag provides the opportunity to show in a positive, non-political way that we appreciate all we have.

Raise the Flag Day focuses at the local level. An easy way to take part in *Raise the Flag* is through the Municipal Flag Program. From coast to coast communities will fly Canadian and municipal flags on the 14th. At day's end, municipalities will send their flags to the national headquarters of the Kinsmen and Kinette Clubs in Cambridge, Ontario. Then, these flags will be taken to Ottawa for the Canada Day festi-

ties on Parliament Hill. Imagine our country's community symbols flying proudly beside our national colours. Look for your community's flag during the telecast!

Why don't you involve your group or section?

The Canadian Flag. A proud symbol of the rights and freedoms we enjoy as Canadians.

Contact your local Kinsmen or Kinette Club. If the Club sponsors your group, what could be easier? Find out what type of activities are already planned in your community and join the fun. Many communities are already planning day-long celebrations.

Plan a special flag-raising ceremony at your Scout meeting closest to May 14th. For International Year of the Family, encourage family members to join the meeting or to raise the Cana-

dian flag at home. Make sure your Scout Hall, office or meeting facility flies a Canadian flag. Plan some special program activities in early May. Practise folding, raising and lowering the flag. Learn the proper way to fly a Canadian flag. Find out when we first flew our national flag. What is significant about its design?

More ambitious groups can work within their community to host *Raise the Flag* activities. Coordinate a flag raising ceremony at City Hall with your Mayor. Encourage your local city council to proclaim Saturday, May 14th *Raise the Flag Day*.

Most importantly, have fun celebrating Canada. *Raise the Flag Day* will remind us all to take out our flags and fly them in proud support of Canada. Keep them flying so you'll be ready to help celebrate Canada's 127th birthday on July 1st. Be sure to tell the **Leader** about your activities (don't forget photographs).

Obtain a free *Raise the Flag* information kit by calling coordinator Karen Matthews at (519) 653-1920, or write: Kinsmen & Kinette Clubs of Canada, 1920 Hal Rogers Drive, Cambridge, Ontario, N3H 5C6. FAX (519) 650-1091.

Executive Editor
Garth Johnson

Editor
Allen Macartney

Art Director
Richard Petsche

Advertising
Laureen Duquette

Circulation
Pam Phaneuf

Cover photo: Paul Ritchie

The Canadian Leader Magazine is published 10 times a year by Canyouth Publications Ltd., PO Box 5112, Stn F, Ottawa K2C 3H4; (613) 224-5131. Please address all correspondence to the editor. Publications mail registration #2405.

Yearly subscription: registered members Scouts Canada \$7 non-members \$10 outside Canada \$15

The Leader serves as a program resource for Scouters and other adults who work with young people.

Johan Rietveld,
Executive Director,
Communications Services,
Scouts Canada

Editorial contributions are made on a voluntary basis. Unsolicited submissions welcome.

Advertising Policy: Advertisement of a product or service does not indicate endorsement by publishers.

Publishers do not assume any responsibility by warranty or otherwise with respect to products advertised.

The Leader is printed on paper containing 50% recycled fibre.

ISSN 0711-5377



the leader

The Canadian Leader Magazine

April 1994

Volume 24, No.8

FEATURES

Dartmouth East District Soap Box Derby	4
"Bolton Indy 500"	5
Plan A Bird Theme Program!	6
Teddy Bear Sleepover	9
Ballyfin '93: We Were There!	10
Cubs Inducted Into British Army For The Weekend	11
Book Talk	14
Parents Should Be Curious	15
Where Else Has The Patrol System Gone?	16
36th Jamboree On The Air: The Canadian Experience	22
The A-B-C's of Camp Planning	23
Kinus '93: A Great Success!	31
For Service To Scouting	34
Trees For Canada Contest	37

REGULARS

Fun at the Pond A Fresh New Spring	12
Swap Shop Visit Your Local Newspaper	18
For Volunteers Really Remote Training	24
Sharing Get Ready For Friends Of The Forest!	25
Outdoors Fire Safety	28
Paksak Introducing Some New Outdoor Badges	29
Network Faith and Kids: Scouting Hits the Spot	30
Venturer Log Treasures To Remember	32
Patrol Corner Personal Hygiene: Tips and Projects	33

ALSO

Editorial Page	2	Supply News	38
Cross-Country Photos	26	Letters	39
Scouter's 5 & Songs	35		



Driving the Indy 500

page 5



Dartmouth East District



Soap Box Derby

from Crawford Van Horne

Pit crews and drivers buzzed with excitement as they rolled their brightly-coloured soap box racers up into the race positions.

Drivers completed last minute adjustments and safety checks. Excitement sparkled in their eyes. Adrenaline surged as all waited for the starting orders.

Suddenly, the 3rd Annual Dartmouth East District (N.S.) Soap Box Derby began with an excited roar! Accelerating wheels rumbled down the hill as Cubs yelled encouragement to friends. Our racing day had finally arrived!

The long road

Getting to the derby took a great deal of planning and effort by the District Service Team, Pack Scouters, and Cubs.

These cars were not rough racing platforms slapped together recklessly from ill-fitting boards. Cubs built their cars during regular evening meetings

from carefully prepared kits designed to be both aerodynamic and safe for young drivers. All kits came complete with parts, along with easy-to-understand assembly instructions.

Also we used official North American Soap Box Derby Association designs so our cars and teams could race in local non-Scouting events.

Working in teams of six Cubs each, an adult helper provided quality control and help when needed during car construction.

Many packs sought sponsors to help defray costs. Then they decorated their soap box cars, often with sponsor colours and logos as well as additional decals — just like in the big racing leagues!

Preparing for the race meant not just building the cars. We also had to build starting ramps, organize crowd control, plan refreshments, and arrange for first aid help, if needed.

When the BIG DAY arrived our Cubs were ready.

Excitement peaks!

Early on Saturday morning cars and teams appeared at the race site for registration. Races began at 8.00am. This took excellent coordination. With over 30 teams with six Cub-drivers in each team, planning had to be precisely timed.

Every Cub had at least one chance to race his car. With six drivers to each racer the wait could sometimes be unnervingly long! An adult (pit chief) supervised each car and crew to ensure they followed all safety standards. All pit chiefs made sure helmets fit snugly, steering cables were taut, and brakes worked well.

As each driver's turn came, they helped back their car up into the raised starting ramp poised at the top of the hill. When locked in position, cars and drivers were ready for their long, fast, thrilling trip down the race course. We raced cars in two's on a point basis with elimination heats to determine the top cars and riders.



◀ "Are you ready?!" Drivers and cars endure the final moments before a race.



▲ A miniature tractor helped pull soapbox racers up the hill after each race.

Sometimes ▶ waiting is the most difficult part



Between races drivers and pit crews munched hot dogs and discussed strategy in conspiratorial whispers.

The day ended with everyone feeling deeply satisfied with our work and fun play.

Soap box racing lets Cubs build a real racing car while earning badges. It teaches them to work as part of a team toward a goal. It fosters good sportsmanship. It shows them the importance of seatbelts, and road safety.

The event offers other benefits. It provides a great opportunity for other Cub packs and Scout troops in your region to meet. It also makes an excellent summer 'bridge' from one Scouting season to the next, making Cubs or Scouts excited about joining in the fall.

Soap box derby racing has excited youth for over half a century. Treat your Cubs and Scouts to its infectious excitement. ^



A DERBY OF YOUR OWN

Would you like to organize your own soap box derby? Here are a few suggestions.

Choose an out-of-the-way street (approved by local police) with a nice, long, gradual slope. The race site should be quite open (for crowds, refreshment stands and pit crews) and provide plenty of parking spaces for parents and visitors. Don't forget:

- Involve Venturers and Rovers.
- Put a Scouts logo on each car.
- What about press coverage?

Use the race to teach your Cubs proper road safety and how to read road signs. Why not ask a police officer or ambulance attendant to speak to your group during construction?

Involve the whole family in this race event. Parents, brothers, sisters and grandparents can help build, test, paint and fine-tune the cars.

— Crawford Van Horne is a former field executive in Nova Scotia.



"Bolton Indy 500"



by Myles Vanni

To foster community awareness and raise money for future activities, 1st Bolton (Ontario) Beaver leaders organized a "mini-car circuit" during annual Cider Time celebrations last October.

The Beavers loved it. Not only did they enjoy the fun of motoring around a mini town street scene, but they also learned traffic safety and road sign identification.

Leaders borrowed a working stop light and street signs from the town. A farmer gave them bales of hay, while a

local landscaper provided potted shrubs and plants to give a more natural "feel" to the track. After Beaver leaders added a life size pink elephant (from Jumbo Video), an inflatable instant teller (from the TD bank), a mountain of tires, a police car and painted a road course on a parking lot, a replica of a small town awaited the excited Beavers.

But what about the cars?

A local dealer rented 20 electric jeeps, mini-cars, and motorcycles for the event. After paying a small fee, kids raced their vehicles and manoeuvred through the course. A leader, Scout or Cub accompanied each child helping them steer

straight (good thing bales of hay are soft!), and teaching them what the signs mean and how to obey them.

Our "Bolton Indy 500" was a huge success. A hit of Cider Time (excited kids were always waiting in line), parents thought it a great learning experience, we raised money, and it gave Scouting great community exposure.

This event is perfect for late spring, summer or fall. Try it! Involve the whole family. ^

— Myles Vanni is a provincial field executive, Central Escarpment Region, Ontario.



Last minute instructions: always watch the road, keep your hands on the steering wheel, and have fun!



Red light means stop, yellow means slow down, go means go.



Last minute driving lessons.

Photos: Ian Ford

Plan A Bird Theme Program!

by Allen McCartney



Children naturally love birds. Why not plan a series of evenings focused around these feathered friends? Use these ideas to spark the interest in your kids whether Beavers, Cubs or Scouts. Tie many activities into badge work.

Find out what types of birds live in your neighbourhood in the summer and winter. Beavers might enjoy cutting out familiar bird pictures from catalogues or magazines and pasting them onto a colony poster. Taped bird sounds (available at libraries) can serenade your kids during craft activities. Later in the evening young children might want to play the ever-popular "Duck, duck, goose" game.

Let your Cubs and Scouts draw bird pictures, copying the shape and colours from books or posters you get from a library. This will develop observation skills and help children notice subtle differences: Is the body plump or thin? Is the tail long or short? Is it forked, rounded, square or notched? What shape is the beak — thick, thin, long, hooked, dull or sharp? Is the bird brightly coloured or dull? Does it have stripes, spots, caps, or solid colours on its head, back and breast?

Ask your children if they know why birds migrate. The cold of approaching winter drives many birds south where food is easier to find. They return in the spring (a great time to watch for large flocks) to hatch their young and feast in northern latitudes. Migrating birds use river valleys, mountain ranges and coastlines to guide them. Gravitational pull, different air pressures, and sun and moon position navigating may also help. Can your colony, pack or troop think up a good migration game? Try it!

Other animals migrate too. Frogs hop, garter snakes slither, and lobsters parade in single file along the sea bottom to their winter/summer home.

Encourage your kids to watch for birds over the next months.

GUEST SPEAKER

Ask a local animal hospital, Ducks Unlimited or wildlife specialist if they would come and speak to your group about birds in your area. Perhaps they could bring slides and pictures or even a live owl! How can we help birds in our neighbourhood?

BLUE JAY PENCIL HOLDER



Last fall the 45th Brant Beavers (Ontario) made this pencil holder. It proved a popular success. (Thanks to Earl Smith.)

Materials needed: Welch's frozen concentrate juice can (341mL), blue felt, yellow felt (small piece), wiggly eyes, bristol board, 14mm yellow pom-pom, white glue, glue gun.

How to build it

1. Cut a piece of blue felt (22cm x 12cm) so it fits around the can. Glue into place. (For best results coat the can with glue, let it set until it becomes sticky, then roll the can onto the felt.)
2. Cut out two wings (blue felt), one tail (blue felt) and two feet (yellow felt) using the pattern. Cut out two wings and two feet from the bristol board.
3. Glue the blue felt wings onto the bristol wings. Glue the yellow felt feet onto the bristol board feet.
4. Using the glue gun, attach the feet onto the can bottom. Glue wings onto the sides.
5. Glue on the wiggly eyes, tail feather and yellow pom-pom beak.

BLUE JAY PENCIL HOLDER

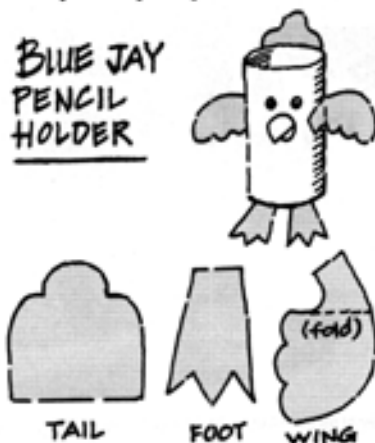

SATURDAY MORNING BIRD SAFARI

Take your Beavers, Cubs or Scouts to a local conservation area to watch birds. Local field naturalists or bird watchers may happily lead the safari. Bring along a bird identification guide and bird seed — often birds will eat right from a child's hand.

Give everyone a small spiral note book and pencil. Ask them to make a list of, or draw, all the birds they see and how they differ from other birds. What are the birds doing? Building nests, feeding young, searching for food, passing time?

Listen to the chirps and the songs they sing. Encourage the kids to imitate birds they hear. Can they identify the birds they see by their calls?

Watch where birds perch. Do big birds perch in the same places as smaller birds? Why? (Smaller birds will usually perch in low branches and in bushes for protection. Larger birds perch at the top of trees.)

Look how different birds fly. Some fly in an arrow-straight line, others in an up-and-down roller coaster ride. Ask the children to describe the flight path of birds they see: swooping, zigzagging, jerky, straight, darting. Does the size and shape of its body affect how it flies? Birds flying an erratic path are often snatching bugs from the air.

Try to distinguish male birds from female and baby birds. Usually male birds sport brilliant colours and display well-defined markings. Females and young have dull, earth colours to protect them while in the nest.

Do you see a hummingbird? If yes, brightly-coloured flowers probably grow nearby. Can you find them? The average hummingbird mass equals that of a penny. Hummingbird wings move very rapidly and use up a huge amount of energy. Each day hummingbirds drink half their own weight in nectar just to keep going — equivalent to an adult human eating almost 1,000 hamburgers a day!

Do you see birds with their feathers puffed up? They are either trying to keep warm (fluffed feathers keep body heat wrapped closely around them like

a blanket), or they want to appear bigger because of a nearby enemy.

CALL BIRDS

On your next hike or nature walk, try calling birds. Stand or sit very still near trees or bushes so you don't frighten them and they can perch nearby. Start calling when you see them.

Birds respond to different rhythms. Try these calls and experiment with the rhythms; all calls make a gentle "pssh" sound.

Psssh-psssh-psssh... pssssshhhh...
Psh... pssshhhh... psh...
Pssshhh... psssshhh...

If the call is effective it will attract a bird almost at once. Try different patterns. Wait patiently for cautious birds to approach. This call will attract small birds like sparrows, chickadees, nuthatches, wrens, and jays. Don't expect eagles to give a low fly-by!

FIND AN UNUSED NEST

Find an empty bird nest during your Saturday morning bird watching safari. *Make sure no birds are using it.* Never disturb eggs during the nesting season.

What is the nest made from (twigs, cobwebs, leaves, feathers)? Use a magnifying glass. Where did the birds get the building material?

Place the nest in a shallow pan of water for several weeks. Watch for sprouting seeds. Can you tell what plant is growing from the nest? How did they get into the nest? Does this tell you anything about the eating habits of the birds who used this nest?

Explain that birds help keep gardens healthy by eating insects, thousands of tons of weed seeds each year, and controlling the rat and mouse populations (owls, hawks).

DID YOU KNOW...?

- When birds fly they use up enormous amounts of air. Rather than panting like a dog, many birds have extra air sacs in their lungs that reuse air, squeezing all the oxygen out of a breath. Without these extra air sacs, summer days would be filled with the sound of panting birds!
- Especially smaller varieties of birds have a very high metabolic rate and high energy needs. They must eat large quantities of food each day just to survive. Sometimes this is 40-75% of their total body weight! How much food would you have to eat if you were like these birds?

BIRD QUIZ

Q: Do birds like peanut butter?

A: Many birds *love* peanut butter! It tastes great and provides lots of energy for swooping around trees and houses.

Q: Will birds eat almost anything?

A: No. Just like humans (especially children?) birds are often picky eaters. Some birds just eat bugs and larvae while others eat seeds. Some love sunflower seeds but avoid corn and grain mixtures. Find out what food your favourite birds eat.

Q: How can you attract birds?

A: Seed will usually attract birds, but not all of them. Hummingbirds drink nectar from flowers. These little birds would love it if you plant bright red flowers in your garden — red is their favourite colour. Birds have other needs too. Shrubs, trees and tall plants provide a place for them to build nests, eat berries and hide from predators. If you live in a dry area birds might like a bird bath to splash in and drink from.

Q: Do some ducks live in bird houses?

A: Wood ducks, mergansers, and buffleheads will live in special bird houses you can build. These must be close to lakes and rivers. Look for plans at your library.

Q: What is suet?

A: Suet is hard fat trimmed from beef or lamb. Many people feed it to birds in the fall, winter and spring because it gives a lot of energy. Ask your local butcher for suet. Don't hang it out in summer

— it will turn rancid and cause sickness (not to mention smell bad).

Q: Why do some birds have long skinny beaks, others have short, fat beaks, while yet others have hooked beaks?

A: The type of beak a bird has tells you what type of food it eats. Birds with short, thick beaks use it for cracking seeds (e.g. grosbeaks). Long, thinner beaks are perfect for eating bugs, soft seeds, or fish (e.g. terns or nuthatches). Eagles and falcons have hooked beaks so they can grasp and eat meat.

Q: Why do all baby birds have large, brightly-coloured mouths?

A: Large mouths make it easier for busy mother birds to see and feed their babies.

Q: Why do birds have feathers?

A: Feathers (like animal fur) provide warmth and protection. Feathers give water birds (ducks, loons, terns) buoyancy so they can easily float. Birds also use their feathers during courtship — sometimes to make a gaudy display like a peacock.

Q: How do birds fly?

A: Bird wings (like airplane wings) are curved on the top and relatively flat on the bottom. Air rushes faster over the curved top creating a lower air pressure that literally sucks (lifts) the entire wing upward. Birds flap their wings in a figure eight motion: the tips twist and push air backwards, providing forward thrust.



Get your kids outside to experience birds for themselves.

- The French call hummingbirds, "oiseau-mouches" (fly or bug birds) because they are so tiny.
- Arctic terns fly around the world every year! They winter in Antarctic seas (extreme south) and spend their summers in the Arctic (high north).
- Birds will help keep your garden strong and healthy. They will also help make summers more enjoyable for sitting out because they love eating bugs. Wrens, swallows and purple martins particularly delight in mosquitoes, garden pests, and flies.
- The ostrich is the largest bird in the world. It lives in Africa, stands 3m tall and can't fly. Each egg weighs almost 1.5kg!
- Birds have a poor sense of taste and smell, but exceptionally good sight and hearing. ^

Program Links

Cubs: Black Star, Observer, Tawny Star, Carpenter, Handicraft, World Conservation.

Scouts: Conservation, World Conservation.

CUB/SCOUT WORD SEARCH

Can you find all the birds hiding in this puzzle? Divide your pack into sixes to compete; Scouts can race against a stop watch.

Hiding birds include: eagle, chickadee, bluebird, swan, gull, teal, duck, tern, heron, sparrow, hawk, grosbeak, robin, owl, thrush, warbler, cardinal, finch, dove, martin, swallow, wren, woodpecker, blackbird, magpie, jay, falcon.

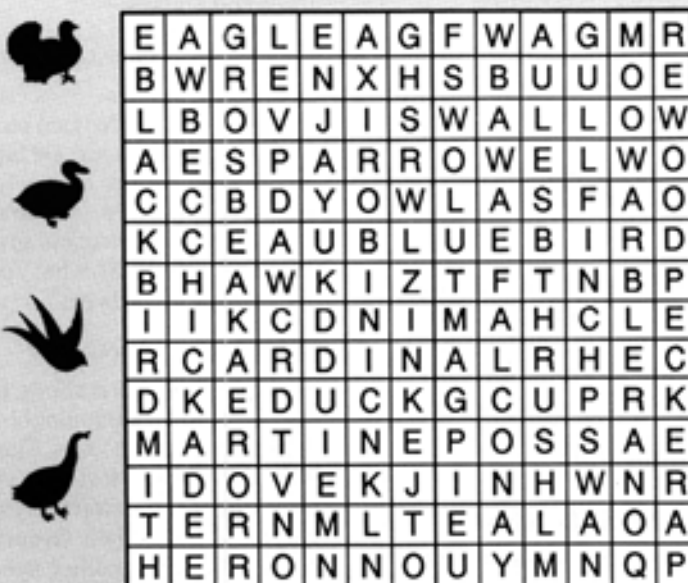

BUILD A BLUEBIRD HOUSE

Bluebirds prefer a deep nesting box set on a post near a garden. They eat almost anything: lawn insects in summer, fruit and berries in winter.

To keep starlings and house sparrows out of your bluebird house make the entrance hole no larger than 4cm (1.5") in diameter. This is critical. Also, place the house only 1 1/2 - 3 metres above the ground in the open.

Score the inside of the bird house below the entrance hole with a saw or chisel. This will help young birds climb out. Most birds prefer a brown or green house, never a bright white or red.

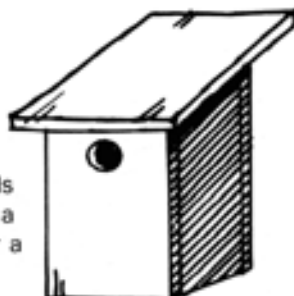

Materials you will need

- 12mm plywood
- pine strip (20mm x 20mm x 150mm) — for roof cleats.
- nails or brass screws.

Cut one floor: 12mm x 125mm x 125mm.

Cut two sides: 12mm x (265mm in back to 228mm in front) x 125mm.

Cut one back: 12mm x 265mm x 150mm.

Cut one front: 12mm x 228mm x 150mm.

Cut one roof: 12mm x 255mm x 228mm.

Cut two roof cleats: 20mm x 20mm x 75mm.

Begin construction by assembling the sides, front and back around the floor. Drill very small drainage holes in the bottom of the floor and 10mm wide ventilation holes on each side at the top. Nail or screw the sides to the floor. Don't nail the roof to the bird house. The roof cleats make it easy to remove the roof for fall and spring cleaning.

All bird houses need to be cleaned out at the end of the season. This removes old nests, disease and parasites, and gets the house ready for its next occupants.

Beaver-aged children will need close supervision. (This might be a good project to invite parents to help.) After you demonstrate safety procedures, let your Cubs cut some of the wood for their bird houses themselves. Scouts will want to do all the sawing, nailing and painting on their own. If your troop wants a more advanced project they could choose to build purple martin or owl houses. Libraries have plans.

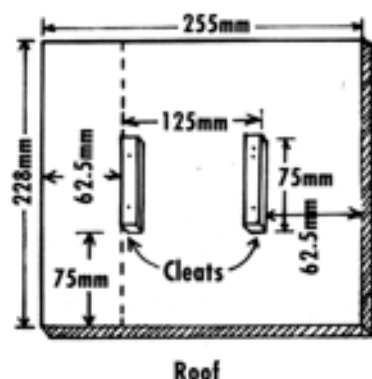
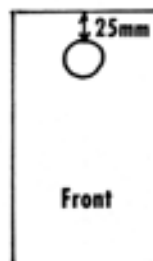
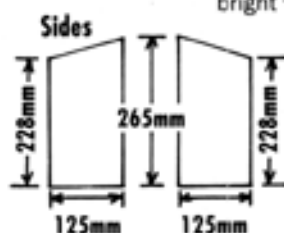



BACCALIEU DISTRICT

Teddy Bear Sleepover



by Marie Brookings, Melitta Foote and Cindy Cooper

Last November approximately 65 Beavers and leaders from four colonies in the Baccalieu District (Newfoundland) gathered for a fantastic Teddy Bear Sleepover party.

A very full activity program including songs, games, skits, crafts, and more kept everyone "beary" busy!

The fun started immediately after registration and opening ceremonies, although most Beavers squealed with delight as they scrambled to pick out their bunk ("I've got the top one!").

Everyone loved singing. "The Bear Went Over The Mountain" and "Teddy Bear, Teddy Bear" proved irresistible for all voices — young and old.

How do you settle excited Beavers? Our idea involved making teddy bear party hats. Beavers coloured pictures of teddy bear faces, glued on googly eyes, and attached them to strips of cardboard cut to size for each Beaver's head. Great!

"Honey Pot" (an action game) reversed the quiet peace established during craft time. Our Beavers swarmed around, buzzing and burning off energy. Soon they were ready for a quiet story, "The Blue Ribbon Bear", read and performed by leaders.

Soon all Beavers gathered around our inside campfire where they watched a fun "Goldilocks and the Three Bears" skit. Just in case Beavers were starting to wilt too early in the evening, we sang an action song, "Father Abraham". Few songs can tire a Beaver faster than this spinning, shaking, turning and bending chorus!

The night's last activity involved (what else?) a teddy bear picnic. All gathered around a large picnic basket filled with cookies and juice. Despite many yawns and much eye rubbing, hungry Beavers emptied the basket quickly. Big surprise?

Before long Beavers slid into warm sleeping bags and happily drifted off to sleep hugging their favourite teddy.

Next morning we discovered freshly fallen snow. Beavers couldn't wait to run outside, roll around, build snowmen, and go exploring. Everyone watched closely for animal tracks as we enjoyed a nature hike through the woods near our chalet (lodge).

Parents soon arrived and gathered up their happy, well-satisfied teddy bear Beavers. What a success!



Honey Pot Game

Bears love honey. Sometimes they get into terrible trouble trying to take it from bee hives.

Two leaders (the bees in a hive) crouch in a circle in the middle of the room with two small paper cups (the honey). The bears (Beavers and their teddies) roam around outside the circle trying to get the honey. When the bees jump up and shout "SWARM!", the bears scatter to safety (touch a wall) before a bee catches them. Caught bears can help the bees.

Father Abraham

Father Abraham had seven daughters,
Seven daughters had Father Abraham.
And they could not walk
And they could not talk
And they could not even sing.

Notta one... shake right hand.

Notta two... shake both hands.

Notta three... shake both hands
and one foot.

Notta four... shake both hands
and both feet.

Notta five... shake both hands,
both feet and nod head.

Notta six... shake both hands, both
feet, nod head and bend at waist.

Notta seven... shake both hands,
both feet, nod head, bend waist
and turn around. ^

— Marie Brookings, Melitta Foote and
Cindy Cooper work with the 1st Old Per-
lican Beaver Colony, Nfld.



Shane Driscoll and Ryan Doyle, two sleepy Beavers, head off contented to their bunk.



Teddy Bear Beavers loved making party hats.

Ireland's Ballyfin '93:

We Were There!

from Lynda Koudys

“I hope this harness and rope will hold me,” Venturer Philip Hinds murmured hesitantly, standing at the top of a towering rappelling wall. Fifteen metres below him the green grass of Ireland blew gently in the breeze.

“If it can hold me, I'm sure it will hold you!” said Scouter Andy from Scotland. “Go ahead lad; you can do it!”

Moments later Philip stood at the bottom of the wall, beaming.

At the Ballyfin jamboree in Ireland last year our composite Venturer Company (1st Grimsby, 1st North Grimsby and 26th Niagara, Ontario) all experienced the feelings Philip felt on the rappelling wall: anticipation, thrill, pride, satisfaction.

Our trip to the Ballyfin jamboree began with two days touring Dublin, Malahide Castle, and St. Patrick's Cathedral. Wonderful! Then we were off to the jamboree site.

The adventure, challenge and thrill of meeting in Ireland attracted 8,000

youth and adult volunteers from countries as culturally diverse as Switzerland, Belarus, and Bosnia. Two Scouting groups came from Canada: one from B.C. and ours from Ontario.

Together we pitched our tents.

The magnificent jamboree site sat on a beautiful, spacious green meadow surrounded by picturesque, rolling hills near the foot of Bluestack Mountain. A sea of green canvas and colourful nylon tents soon filled the meadow.

Here we spent ten wonderful days living, working and playing together, demonstrating to the world our Scouting beliefs and values of international brotherhood.

Ballyfin wasn't just any jamboree, but the third in a series of three camps jointly organized by the Scout Association of Ireland, the Scout Association of Northern Ireland, and the Catholic Boy Scouts of Ireland (the 1993 host organization).

The jamboree offered a wide range of activities including: hill climbing, orienteering, parascending, archery, rappelling, rafting and canoeing.

Fun events and competitions abounded. We enjoyed talent shows, international soccer games, cuckoo awards, and even a world record-breaking centipede style walk, involving 1,200 Scouts! (Watch for the announcement in the next *Guinness Book of Records*.)

“Challenge Valley” (a highly-creative, brutal assault course) was a favourite activity for all. It involved leaping over five metre high walls, scurrying through culverts, climbing rope ladders, squeezing through wooden mazes, balancing on thin rope bridges, racing (and slipping) into mud pools, and sliding down a wild water slide.

During some quiet moments we exchanged badges, sang songs, gathered around campfires and told stories.

All over the jamboree site Scouts put their hearts together during UNICEF Day and donated CA \$26,000 for those in desperate financial need. As a group, we left our dining shelter for Bosnian Scouts to enjoy. (They arrived with no Scouting equipment at all.)

How did Ballyfin differ from a Canadian jamboree? We needed no insect screens! Very strange, but a welcome surprise.

Ballyfin was an excellent Scouting experience.

Did we miss CJ?

Yes. Australians who attended it only weeks before told us all about the fun. But we loved Ballyfin: Irish hospitality, warm conversations, cheering until our voices cracked, neat adventure hikes.

A foreign jamboree extends your horizons. It exposes your Scouts to new cultures, fresh experiences, unusual friendship-making opportunities. It sharpens your awareness of Canada.

Why don't you attend a foreign jamboree? See you in Holland in 1995? ^

—Lynda Koudys works with 1st Grimsby (Ontario) Venturers.



Challenge Valley's wobbly rope bridge. Easy does it!

Enjoying a quiet moment resting in our dining shelter.



Ed's note: The Leader regularly publishes details of similar international events around the world. Watch for these notices or contact Scouts Canada's International Relations and Special Events Service (national office) for information and registration details.

Cubs Inducted Into British Army For The Weekend!

by Al Corace

What was it *really* like in the mid-19th century British Army?

Last fall, when they visited historic Old Fort Henry in Kingston (Ontario), 1st Manotick (Ontario) "C" Pack Cubs found out first-hand the rigours young British soldiers endured.

Built on the banks of the St. Lawrence River by Royal Engineers, Fort Henry was to protect Canada from American military threat.

The visit formed part of an "Experimental Learning Program" that allows youth to creatively experience life in pioneer days in a realistic, often dramatic, fashion. When the Cubs left their cars, Fort Henry's staff helped carry them back to the mid-19th century when the British Empire ruled one quarter of the world's population.

"SNAP TO IT!"

Fort Henry Guard officers barked out orders as the pack arrived for this educational, fun-filled weekend. After roll-call, officers marched the Cub-recruits to their barracks where they chose bunks and stowed equipment. Next, Fort Henry staff fitted Cubs with their own period uniforms.

You could feel the excitement bouncing off the barracks walls as

both Cubs and leaders slipped out of Toronto Blue Jay sweat pants and into their Queen Victoria-era, British Army uniforms.

During the next two days Cubs spent time on the parade square, in the bakery, in the barracks, on guided tours, and in a stone schoolhouse. (Each training module lasted about 30 minutes.)

In the schoolhouse Cubs learned about Fort Henry's history, the life of army recruits and the global extent of British rule in 1867.

Long ago the parade square formed the centre of the universe for new recruits to the British Army, as cold-hearted drill instructors knocked them into soldiers. Our Cubs were no exception.

"LEFT FACE!"
"RIGHT FACE!"
"ABOUT FACE!"
"NOT THAT WAY!"

Very quickly "C" Pack Cubs learned correct marching manoeuvres, how to salute, who to salute, and when.

After marching came rifle instruction. This included a real firing demonstration.

KABOOOOM!!! Very popular!

Marching, saluting, fascinating pioneer stories, rifle drill all make



Not always a custom fit — just like the 1860's! Scott Campbell looks for his hands as Arron Muson helps. In the back row Andrew Karn (left) and Christopher Wandell (right) listen to old fort stories.

hungry soldiers. In the Mess Hall our Cubs wolfed down fresh, piping-hot bread (baked in original pans in the bakery's wood-burning ovens) and hearty stew.

Cubs soon learned that British soldiers knew little about privacy and convenience. Guided by instructors, Cubs quickly saw and felt the harsh living conditions young recruits tolerated.

The Cubs' imagination peaked when they visited the Officers Quarters at night using only candles, looking for the ghost that haunts Fort Henry.



Baking bread in the wood-fired ovens produced amazing results!

DISCOVER YOUR HERITAGE

Is there a similar experimental learning program in your area? Perhaps a local fort, pioneer village or museum offers an overnight learning adventure. Many provincial and national parks run flexible programs (or will create one) to meet the needs of your group. Why not ask? What better way for your Cubs and Scouts to really experience their heritage?

Remember the old Chinese proverb: "I hear and forget; I see and remember; I do and I understand." ^

— Al Corace is Akela with the 1st Manotick "C" Pack, Ont.

Fun at the Pond

by Lena Wong



Welcome to a fresh new spring! What an ideal time to get back outdoors regularly to expand your program.

Plan at least one trip into the bush, a park, the beach or the woods. Take some magnifying glasses for close-up discovery, paper and pencils for bark rubbings and nature drawings, and other useful objects for having fun outdoors. Bring along some sandpaper and a spray bottle filled with water on your walk. Here is a great idea for discovering something new about trees.

Ask your Beavers to look for a flat-topped tree stump. When they find the stump, sand the top and spray with water to get a clear view of the rings. Explain to the Beavers that each year a tree grows a light and a dark band of wood around the tree's diameter. These bands are called annual rings. Starting at the centre of the tree, let your Beavers count the number of rings to discover the age of the tree when it was cut down.

Now help the Beavers measure the distance between the annual rings. The lighter bands of wood, called spring wood, form during spring when the tree gets plenty of water. The darker bands, called summer wood, form during the drier summer months. Wide rings show a wet year of rapid growth; narrow rings identify dry years when growth came slowly.



Identify the two types of wood in a tree. The heartwood is the oldest and strongest, found toward the centre (or heart) of the tree. The sapwood is the younger and softer wood found closer to the bark. You will also find that the sapwood is lighter in colour than the heartwood.

Explain to the Beavers that it is important never to abuse the bark of a tree because it protects the tree from damage and disease.

KITES

Children and kites always make a successful combination. Try building these two simple kites. Your Beavers will love them!

Collage Kite

Cut a kite shape from a heavy shopping bag. Glue on lightweight collage materials (bits of paper streamers, cut-out pictures, shapes cut from tissue paper, etc.). Tie on a tail made from light stringing materials (paper candy cups, butterfly shaped pieces of tissue paper, bits of foam). Tie a string to the other end of the kite. Hold on to the kite's body to keep it in the air.

Collage Kite



Paper Bag Kite

Gather together a large paper bag, string, collage materials, glue, paint, tissue paper and paper streamers.

Punch a hole in each of the four corners of the paper bag about 7.5cm from the edge. Cut two pieces of string approximately 80cm long. Tie each end into a hole forming two large loops. Cut another piece of string the same length and tie it through the two existing loops to form a handle.

Paint the bag and decorate with collage materials and paper streamers. Allow to dry.

Now the fun begins! To fly the kite, open the bag, hold on to the string and run so the wind catches inside the paper bag.

Looking for a really easy, quickly-made kite?

Use a plastic grocery bag with handles; just thread a string through the existing handles.

Go for a kite flying session using your home made kites. For added fun, ask the Beavers to bring kites they have at home.

ROCKET FUN

Looking for an indoor experience offering both fun and experimentation? Why not try this rocket idea from the December/January issue of **Family Fun** magazine?

For each rocket you need a ball of string and a pair of scissors, a large cigar-shaped balloon, a drinking straw, plastic mailing tape (or other strong adhesive tape).

Tie one end of the string to the ceiling. Unwind enough string to reach the floor and add an extra 7.5cm — 10cm. Thread the string through the drinking straw and tape the string to the floor.

Inflate a balloon and hold the end shut while you tape it to the straw close to the middle.

Your Beavers will love what happens next. Have them count down from 10 to 0 while holding the rocket assembly close to the floor. On the count of "zero", yell "LAUNCH!", release the balloon and watch how fast it shoots to the ceiling.

Explain to the Beavers that the string and straw keep the "rocket" on its trajectory. The air escaping from the balloon in the opposite direction makes the lifting thrust. Real life rockets use the same principle when they leave their launching pad to go into space.

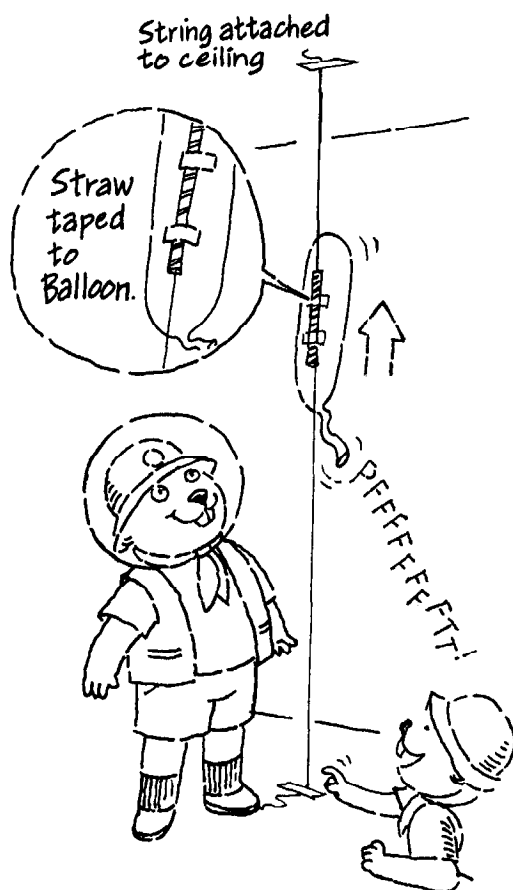

DRAGON THEME NIGHT

Plan a dragon theme night. Arrange the evening so you can spend part of it outdoors and part indoors.

April 23 is St. George's Day, a day which is celebrated quite extensively by Scouts in the United Kingdom. St. George is the Patron Saint of England and of Scouting. According to legend, St. George rescued the King of Sylene's daughter from a hungry dragon that was threatening to eat her. The story, of course, is really a tale of how good triumphs over evil.



Baden-Powell chose St. George as the Patron Saint of Scouting because he exemplified the qualities of devotion, piety, courage, leadership, truthfulness and dedication — the same qualities Baden-Powell wanted to encourage in young people.

British Scouts celebrate St. George's Day at a district level. Why don't you celebrate it at a colony level? Here are a couple of ideas borrowed from the February issue of U.K.'s **Scouting** magazine, ideal for a dragon theme night.

St. George and the Dragon

— The Game

Divide the colony into two teams one called "George" and the other called "Dragon". Place the teams facing each other across the length of your hall or a marked-off outdoors play area. On the command "Go" the teams slowly advance towards each other, using the appropriate actions for their names (dragons slink and hiss; Georges use riding motions) until they are a few feet apart.

A leader now shouts either "George!" or "Dragon!". The identified team tries to capture the other team. The escapers try to get away to their end of the play area.

Continue the game until everyone is tired and ready for a rest. Read some stories about dragons while the Beavers catch their breath.

Pin the Tail on the Dragon

This is a variation on the ever-popular party game. Draw a tailless dragon on a large piece of paper and pin to the wall. Make a windy, pointed drag-

on tail and get your blindfolded Beavers to pin the tail on the dragon.

Looking for a variation? Try pinning the head on the dragon, or the wings (or even head, tail and wings). Take some pictures to show the Beavers what their funny creations looked like.

A Dragon Mural

Pin a long piece of paper onto the wall and ask Beavers to draw pictures using the dragon theme. Some Beavers can draw castles, others knights on horses, while others can draw roaring, dangerous, flame-belching dragons. Include some scenery of trees, clouds, houses and other fillers in the picture.

Use pictures from old comics or magazines to make your mural particularly interesting. Cut these out and glue them onto the dramatic mural. Use bits of coloured cloth to form the dragons; make clouds from cotton wool. Small twigs make realistic bushes and trees.



MOTHER'S DAY

May 8 is Mother's Day — a good opportunity to practise craft skills.

Fancy Note Pad

For each pad you need a washed foam meat tray (or a piece of heavy cardboard covered with cloth or wallpaper), a small purchased note pad, bits of coloured paper or cloth, scissors, glue, a length of ribbon.

Glue the note pad onto one half of the meat tray. Make a flower collage using cloth or paper on the other half. As an alternative, glue a photo of the gift giver onto the tray next to the note pad.

A Heart Card

Provide each Beaver with a heart cut from red bristol board and a quantity of small cotton balls. Draw a picture or glue a photo onto the centre of the card. Write a message on the other side. Glue the cotton balls around the edge of the card. Allow to dry.

Enjoy April but let's also look forward to May's warm weather! \



Book Talk

by Dave Jenkinson



Did you know that almost half of Canadian children have either a dog or a cat as a pet? These four legged members of the family now have their own "baby books" thanks to Marilyn Baillie, an editor at *Chickadee*, the children's nature magazine.

The pair of illustrated books, *My Dog* and *My Cat*, which share the subtitle "A Scrapbook of Drawings, Photos and Facts," not only provide Cubs and younger Scouts with information about their pets, such as how and when to feed them, but the books also invite animal owners to "fill in the blanks" with bio-

graphical details about their own particular animals. The books also encourage children to draw pictures or take photos of their pets and add them to its pages. The author shows young pet owners how to make paw prints, construct a cat or dog bed, and gives recipes for healthy treats. Dog owners even get some practical "how to" tips on training their furry companions. When completed by the child, the book would make a great souvenir of fun times shared with an animal friend. (**Cubs: Pet Keeper; Scouts: Pet Care**)

A spread from 'My Cat' makes it purr-fectly clear how cats keep clean!



graphical details about their own particular animals. The books also encourage children to draw pictures or take photos of their pets and add them to its pages. The author shows young pet owners how to make paw prints, construct a cat or dog bed, and gives recipes for healthy treats. Dog owners even get some practical "how to" tips on training their furry companions. When completed by the child, the book would make a great souvenir of fun times shared with an animal friend. (**Cubs: Pet Keeper; Scouts: Pet Care**)

What child doesn't dream of being a magician? Now, aspirants to the art of legerdemain can turn to Lawrence Leyton's *My First Magic Book* which offers complete, step-by-step instructions for making and performing one and a half dozen magic tricks.

"Feats" such as how to pull a bunny (a toy one) out of a box, or make a silk

handkerchief disappear, or change colour, are clearly illustrated via photographs in this large format book. You can construct most of the magic props, such as the "Dancing Matchbox" and "Genie in a Bottle", from everyday materials. Consider having your older Cubs or members of a Scout patrol each select, make and master one of the book's tricks; then take your troupe of prestidigitators to perform before another group or section. Why not have a magic theme night and tell the Leader about it? (**Cubs: Troubadour 7; Scouts: Entertainer**)

Sometimes, the pairing of "soap" and "children" sounds like trying to mix oil with water. J.L. Bell's *Soap Science* may cause some 8 to 12-year-olds to look at this seemingly "hated" substance somewhat differently. As well as providing factual information about soap (such as how it is made), the book provides 36 experiments for Cub and young Scouts-level children. Those who don't believe that washing hands makes a health difference should try the "Why We Wash" experiment. It's one you could start at one weekly meeting and then check the "hairy" results at the next.

Many *Soap Science* activities are easily turned into just plain fun. Get Lodge or Six members to save their bits of leftover soap scraps, then organize an evening at someone's home recycling them back into bars of soap. Beavers could make a "Sudsboat" for use in the bathtub. Be certain to send home in-

structions on how to "refuel" the boat. Everyone in the Scouting family will enjoy the bubble projects as they make and use their "Bubble Brew" and their Loop, Hoop or Zubrowski bubble blowers. (**Cubs: Red Star A3, Handicraft 1; Scouts: Science**)

Is the next Steve MacLean, Marc Garneau or Roberta Bondar already part of your troop or company? Norman Schmidt's *Discover Aerodynamics With Paper Airplanes* will encourage any budding astronaut by tying learning directly into fun activities. The slim book's first two parts deal with the history of flight and the basics of aerodynamics; the final segment, "Experimental Flight", serves as the practical application of what readers have learned. Schmidt provides three reproducible masters of different airplane designs plus detailed, illustrated instructions for assembling the paper planes.

As a Scout/Venturer alternative to Kub Kars, try Schmidt's ideas for competition flying in the form of "straight and level," "manoeuvres" and "landing" events. He even supplies directions and full scoring instructions for your "air show". Once your gang have all earned their wings, take your paper flying circus barnstormers to other pack and colony meetings! Use this book to plan several fun evening programs. (**Cubs: Handicraft 2; Tawny Star A5; Scouts: Modeller**)

Baillie, M., *My Cat: A Scrapbook of Drawings, Photos and Facts*, (Illus. by Clark, B.), Kids Can Press, 1993: \$12.95.

Baillie, M., *My Dog: A Scrapbook of Drawings, Photos and Facts*, (Illus. by Clark, B.), Kids Can Press, 1993: \$12.95.

Bell, J.L., *Soap Science*, (Illus. by William Kimber), Kids Can Press, 1993: \$10.95.

Leyton, L., *My First Magic Book*, Stoddart, 1993: \$16.95.

Schmidt, N., *Discover Aerodynamics With Paper Planes*, Peguis, 1991: \$14.95

Parents Should Be Curious

by Dave Tyre

Sometimes Scouting activities concern parents. Sometimes our whole program sparks curiosity. Focusing on outdoor programs at all levels, Scouting brims over with ritual and lore. Naturally, this puts some parents on edge when their children talk about their first few meeting nights.

Mom asks a youngster just home from Beavers what he did at the meeting. "We made paper dogs," the child replies.

"That's nice. What else did you do?" she asks.

"Well, my lodge...."

"Lodge? What are you into? What else happens?"

"Well, there's Riverbanks."

By this time, a parent should be curious enough to check out this strange organization. Of course, one meeting clears up everything as parents learn that Beaver ritual is based on make-believe suited to that age group.

Wolf Cubs pose other questions. Home comes the child to tell parents about Akela, Baloo, Raksha, and Kaa. There are Grand Howls, and the totem (a totem!) is a wolf head. A question about Akela brings the reply, "She's an old wolf."

That's normal. Happens all the time. And what about Baloo? "He's a bear." Really?

If the parent swallows all this, next week the young Cub announces, "I need this week's bones." (Kids usually say this when you have a mouthful of hot liquid!) At that point, a fond parent probably considers it prudent to look in on a meeting. Once there, the sight of a fully grown adult shouting, "Pack! Pack! Pack!" and 20 Cubs converging noisily in a circle will put parents who know nothing about the program into a spin. After the Grand Howl, most will be wondering what form of cult this is. It is make-believe, too, of course, and kids of Cub age enjoy it all.

Then comes Scouts. The child arrives home and announces an immediate requirement for hiking boots,

several sets of designer camp clothes, gaiters, compass, advanced first aid kit, cool shades, therma-rest mattress, high-tech slab mummy sleeping bag, 14 L contour internal frame pack, and a small battery-powered colour television.

The parent sighs. Whew! This is more like it. This is what Scouting is all about! The following week, the young Scout begins to leave earlier than normal for the meeting.

Answer Parents' questions thoughtfully.

"Hold it right there. Why are you going so early?"

"Court of Honour meeting."

"What's that?"

"It's secret!"

Is there no end to this?

Venturers should put parents' minds at ease, right until the 15 year old walks through the living room with a bundle under one arm.

"What's that?" asks the interested parent.

"A parachute!" the teen replies.

Visions of the household's beloved leaping from a perfectly serviceable aircraft rush to mind. "Oh no you're not!" the parent cries.

"Not what?" asks the Venturer.

"You're not going skydiving."

"Oh," the teen smiles mischievously. "We already did that. This is to take to the next Venturer Conference. Sort of a ritual."

Too late mom.

The Rover program doesn't escape the parental wondering. Mom, dad, maybe you shouldn't ask. The Rover who lives in that square metre in front of your refrigerator is, after all, an adult. Sure, there's some ritual and secrecy left. Candlelight ceremonies, swords, ... oh, why fight it? After all, the whole crew showed up at the last blood donor clinic, and they're helping

out at the Seniors' Centre three days a week. Once they're recruited as adult leaders, things will settle down.

These beads and the woggle? Well,... uh, you see they're sort of tradition. Nothing weird, you understand, just symbols. You know... wood smoke, campfires, fellowship, and all that.

ANSWER QUESTIONS CREATIVELY

The parents of young people *should* be interested in their child's evening activities. Don't be surprised if some call you to find out more program details.

What should you say?

If your Scouting parents seem curious, turn them into badge testers, helpers or even leaders. Nothing will answer their questions, or concerns, faster. ^

— Scouter Dave Tyre is regional commissioner, Greater Victoria Region, British Columbia.



Raise the Flag! is a non-political event aimed at having fun by celebrating the Canadian flag. This national service project is an initiative of the Kinsmen & Kinette Clubs of Canada.

On Saturday May 14, 1994 Canadians from coast to coast will celebrate both their communities and their country by raising flags. Join the Kinsmen & Kinette Clubs of Canada as we raise Canadian and Municipal flags on *Raise the Flag Day!*

Obtain your free information kit by calling: Karen Matthews, Raise the Flag Coordinator, (519) 653-1920.

Where Else Has The Patrol System Gone?

by Michael Lee Zwiers

Scouter Ken Middleton (Calgary, Alta.) advocates Scout patrols meet regularly in small groups and come together as a troop only once monthly. In October 1993's

Patrol Corner he presented his arguments well. His scheme might benefit troops boasting a large leadership team, but for many troops his system could prove problematic or even destructive.

I fully support patrols, but in their proper place as a vital part of the troop.

B.-P. wrote: "In all cases I would strongly commend the 'patrol' system: that is, small permanent groups, each under the responsible charge of a leading boy, as the great step to success."

B.-P.'s patrol system provides a marvellous mechanism for channeling Scouts' energy and enthusiasm. Scouter Middleton's article rightly emphasized patrols' value in training Scouts; but I'd like to state a different case for patrols and troops.

B.-P. originally suggested Scouts operate as independent patrols, but that lasted only briefly during this Movement's infancy. When our membership grew, Scouters and Group Committees sprang up around the world and B.-P. advised, "each Scout troop (should consist) of two or more patrols of six to eight boys". While Scouting continued to flourish, B.-P. recognized the importance of patrols working closely within their greater troop. He wrote:

The main objective of the patrol system is to give real responsibility to as many boys as possible. It leads each boy to see that he has some individual responsibility for the good of his patrol. It leads each patrol to see that it has definite responsibility for the good of the troop. Through the patrol system the Scouts learn that they have considerable say in what the troop does.

Their "say" comes through our Court of Honour. B.-P. elaborated:

The Court of Honour is an important part of the patrol system. It is a standing committee which settles the affairs of the troop. A Court of Honour is formed of the Scout Master and the patrol leaders, or, in the case of a small troop,

of the patrol leaders and seconds.... The Court of Honour decides programs of work, camps, rewards and other questions affecting troop management....

Through emulation and competition between patrols you produce a patrol spirit which is eminently satisfactory, since it raises the tone among the boys and develops a higher standard of efficiency all round.... It is the one essential feature in which our training differs from that of all other organizations, and where the system is properly applied it is absolutely bound to bring success. It cannot help itself!

**To succeed,
patrols need
to meet
together
regularly.**

Lord Baden-Powell's ideas offer valuable food for thought today. We should listen well. He saw immediate, good results from patrols in "competitive rivalry" with each other. No longer do Troop Scouters play policeman, teacher and manager. Instead, they become leaders, helping Scouts set challenges and goals for improvement. Working with older patrol leaders and assistants through our Court of Honour, leaders help youths make good decisions about their troop activities.

Inner workings of our Court of Honour may provide material for another article. For now, let's examine ways pa-

troops, under a team of leaders, can compete within their troop.

INTER-PATROL COMPETITION

Every troop I've experienced has an Honour Patrol Award for which Scouts compete. Each month the award goes to a patrol earning top points for inspections, relay races, challenges, and camp activities. First patrol standing in the horseshoe, ready for their opening ceremony, gets 10 patrol points. Closing ceremonies work the same way. Relay race winners receive 5 points. Inter-patrol challenges net even greater rewards. Winners in our camp cooking competition and troop night scavenger hunt grab 25 points. So does the first patrol to build a structure supporting all their members 5 feet off the ground for 3 minutes.

Limitless ideas exist for inter-patrol competitions. Look in your troop resource books or read old issues of **The Leader**. Better yet, have patrols design competitions for each other.

A leader might ask, "What does an Honour Award look like?"

You decide! One troop designed a flag containing crests from camps and events they attended. Another used a small "Honour Patrol" pennant on a pole. My current troop's banner includes crests from each patrol. Winning patrols may display their prize in their corner of the meeting hall each week.

Honour Patrols also carry responsibilities for their Troop, such as:

- running opening and closing ceremonies
- setting up and cleaning the meeting space
- inspecting other patrols
- other warranted special duties and privileges.

KEEP PATROLS INTACT

Whenever possible, keep your patrol members together. Let them camp as

a unit. Play team games with as many teams as you have patrols. If that's impossible, put same-sized patrols on opposite teams.

To succeed, patrols need to function together regularly. Include at least one inter-patrol competition at each troop meeting — even a simple (for organizers!) top-speed relay race across the hall and back. Three more quick ideas include:

- When I say 'GO' I want your patrol to find an object that starts with each letter in the word 'Scout'.
- Without talking, line up your patrol in alphabetical order by last names.
- Get as many of your patrol members as possible off the ground without touching walls or equipment. (The secret is to stack them up like bricks laying on the ground.)

YOUR LEADERSHIP TEAM

Your leadership team forms an important component of a well functioning troop. Ideally, troops boast a Troop Scouter and a Scout counsellor for each patrol. During some part of every weekly gathering patrols meet under their counsellors' supervision. They might plan menus for their next camp, brainstorm ideas for troop outings, or teach each other basic knots in preparation for knot relays. They could work together on a badge or plan their next patrol meeting agenda. Patrol time during troop meetings is a must; a counsellor for each patrol provides needed adult guidance and support.

Leaders should be models of a working team. Demonstrate clearly that your Troop Scouter takes respon-

sibility for the group, but every other member has a role. One could act as troop quartermaster; another could record attendance and finances. A third could maintain troop badge records and purchase stock. A fourth could coordinate camps or hikes. Each patrol should have its counterpart: a quartermaster for patrol equipment who reports to the troop quartermaster, a treasurer, etc..

When patrols hold separate meetings (once every 4 to 6 weeks), their counsellors could attend. Patrols could even plan their own hike or camp with (or without) their counsellor in attendance.

MEANINGFUL COMPETITION

In Scouter Middleton's October *Patrol Corner* he suggested that troops meet only once a month. This idea is fraught with difficulties. What competition is meaningful when you see your rivals only occasionally? What significance has an Honour Patrol Award if you cannot show it off? How exciting are games played by six people at someone's house? How can you share ideas and learn from other patrols when you rarely see them? Do Olympic swimmers race alone in separate pools at the same time? Any athlete will affirm that competition's immediacy provides their motivation for setting new records in a race.

Many of our kids enjoy friendships with Scouts outside their patrols. In such a system, they might see each other only 10 times each year except for camps. Consider your leadership team: they will be certainly involved if they supervise patrol meetings 3 out of every 4 weeks.

What about badge work and skills training? No longer can you let fellow Scouters head sections they know best; you must learn it all. Also, unless you phone your fellow Scouters regularly, you're isolated. You can no longer chat with friends while two other Scouters supervise a game.

COMMON GROUND

True, I'm finding many problems and ignoring benefits of once-monthly troop meetings. Underneath this discussion, I believe Scouter Middleton and I advocate the same thing: active use of our patrol system and active involvement of all Scouts and leaders in our troop. We just see the solution in slightly different ways.

I think our troop system offers many valuable opportunities for developing youth in patrols. I believe large troops using patrols properly in their group setting can counter and correct every complaint Middleton addresses. The choice belongs to you, your leadership team, and your Scouts. Perhaps you will develop your own solution for your unique situation.

Whatever you decide, remember B.-P.'s words: "Foster the patrol spirit and friendly rivalry between patrols and you will get immediate good results in an improved standard of the whole. Don't try and do everything yourself, or the boys will merely look on and the scheme will flag."

B.-P. knew what he was talking about! ^

— Michael Lee Zwiars works with the 34th St. George's Scouts in Dunbar Point Grey, Vancouver, B.C., and serves as a regional trainer.



**It's more fun
playing and
working in a
larger group.**

*(35th Windsor Group
Tecumseh, Ont.)*

Looking for program activities? Try this!

A parent of one of our Scouts is an executive with the *Toronto Sun* newspaper. He arranged for our troop to visit his facilities in the final, most busy stages of producing the paper. Though the staff were extremely busy they made time for us.

When we arrived at each "station" many people said, "Hey, I used to be a Scout!" Then they explained their job and answered questions.

At the end of the tour a newspaper photographer took this picture and a front page heading announced our visit. Fantastic!

What do the parents of your Beavers, Cubs or Scouts do? Are they policemen, fire fighters, ambulance attendants, pilots? I bet they would love to show your group what they do.

After your visit, tell the Leader about it.

— from Ed Aitken, 2nd Highland Creek Scouts, Ont.

Visit Your Local Newspaper



POP BOTTLE XYLOPHONE

Beavers and Cubs love to create and experiment with sound.

Teach them how to change the pitch and tone of sound by filling bottles with more water. Generally, the less water, the higher the sound. The size and shape of the resonating chamber (unfilled portion of the bottle or glass) affects the sound, as well as its construction material (i.e. glass, plastic, wood).

Materials needed

- Gather eight identical pop bottles (same size and shape). Wash thoroughly. (You could use eight identical water glasses.)
- Wooden dowel, spoon (for tapping the bottle).
- Water.

How to make it

1. Fill the first bottle up almost to the top. Blow over the top of the bottle, or gently tap its side with a spoon or dowel.
2. Pour water into the second bottle (or glass) to a lower level than the first bottle (about 2cm) until you reach the next note in the music scale. Use a guitar or piano to help "tune" your bottles if possible.

3. Continue pouring water into the other bottles to an ever-lower level until you reproduce the entire musical scale. The bottle on one side should make a note higher than itself, while the bottle on the other side should make a note lower than itself.
4. Arrange the bottles as in the diagram and label each.

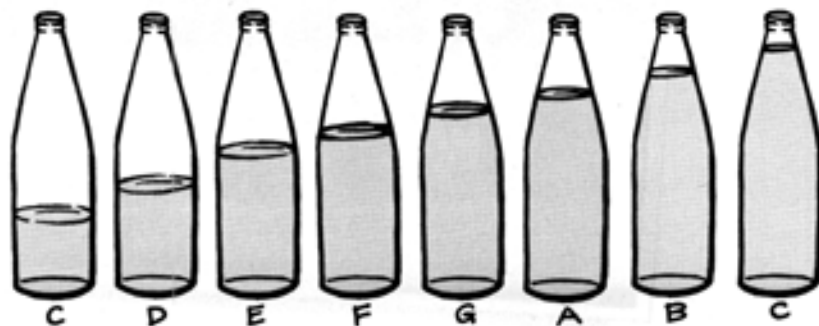

Let the music begin!

Let your children experiment with the sounds. Can they play jingle bells, happy birthday, or another familiar song? Try to play this well-known Canadian folk song: E D C D E E E D D D E G G E D C D E E E.

Encourage your kids to put on a concert. Let them practise a familiar tune (or one of their own creation) for fifteen minutes; then gather everyone around and let the music begin!



For older Beavers and Cubs

Fill one set of bottles with a thicker liquid (oil). Compare the sound from the bottles filled with water and those filled with oil. Does it sound different? Can you guess why?

Get your kids to blow over the top of each bottle. Does the bottle make the same sound regardless how much water/oil is in it? Why does the sound change? Does the bottle make the same sound if gently tapped by a wooden dowel or spoon? Does the sound change if you fill bottles with small pebbles?

— S. Bosak, *Science Is...*, Scholastic Canada. (This book is an excellent resource for program ideas and craft projects.)

BUILD A PTERANODON KITE!

Pteranodon (TAIR-AN-O-DON), meaning “wings and no teeth” was one of the largest prehistoric winged reptiles. With a wingspan of 8m and a body 3m long, it probably floated on air currents waiting for fish to appear. A long crest at the back of its head acted as a giant rudder.

Build this kite and help pteranodons fly again!

Materials needed

- Thin bamboo rod or split cane (from a garden centre).
- Clear plastic sheet (clear garbage bag or plastic available at hardware stores).
- Clear sticky tape.
- Thin black paper (tissue paper is good).
- Masking tape.
- Light fishing line.
- Small metal washer.
- Scissors, saw.

How to make it

1. Tape or tie a large cross of bamboo rod or cane. Tie/tape the shorter cross piece about one third way down the shank of the longer piece (see diagram).
2. Making diamond shapes, link the points of the cross with line. Bind the knots with tape to hold them securely in position.
3. Lay the bamboo frame over plastic sheet. Trim the plastic to the size and shape of the kite, providing extra overlapping plastic.
4. Trim off the plastic sheeting's corners allowing the bamboo frame points to extend beyond the plastic.
5. Fold over and tape the excess plastic sheeting. Turn the kite over.
6. Cut off about 2m of line. Tie one end at the kite's top with a non-slip knot. At the other end of the kite, tighten the line until it is about one hand's width above the plastic kite body.

Tie the line to the end of the kite, letting excess line trail behind.

7. Tie (and tape) tissue paper in knots along this excess trailing line, as in diagram. This provides some weight and stability to the tail.
8. With the black tissue paper draw and cut out a picture of a Pteranodon (or any other art). Attach it to the kite with clear tape.

Plan A Kite Fest

Why not organize a Saturday morning kite fest for your Cubs or Scouts? What a great way to end the season. Why not get together with another pack or troop for your kite fest?

Write to **the Leader** and tell us all about your event. We'd love to hear from you! ^

— Interested in dinosaurs? **Model A Monster** (Sterling, New York) is full of excellent program ideas and crafts.

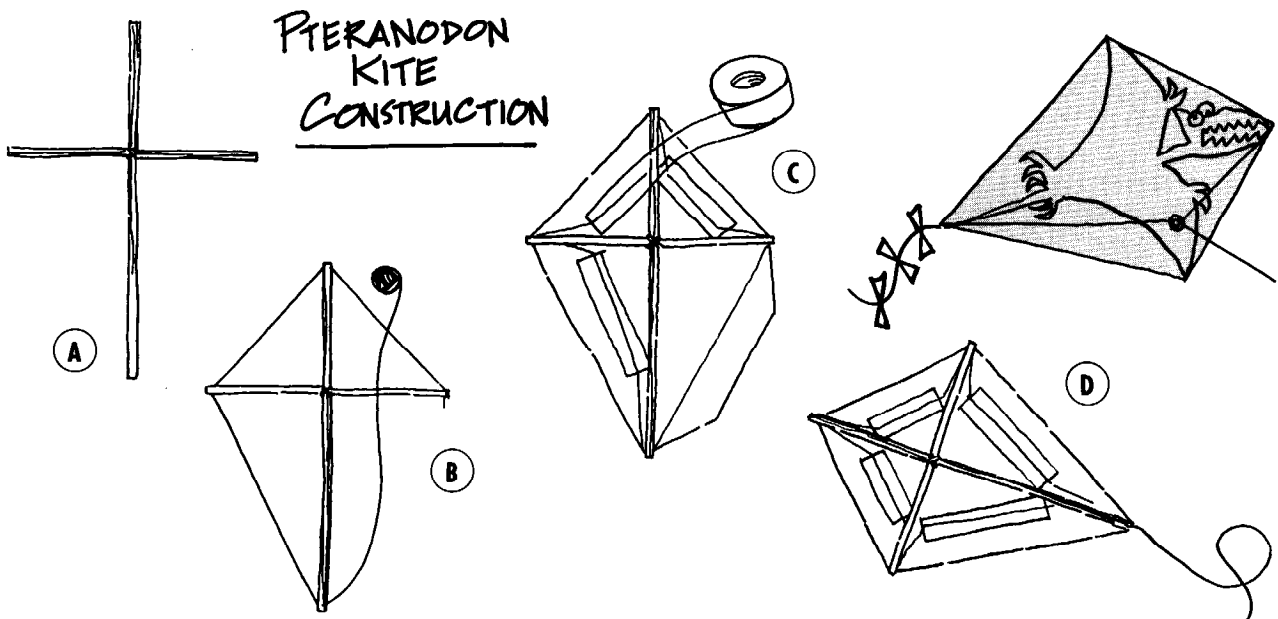



36th Jamboree On The Air: The Canadian Experience

by Leno Wong

Though fewer Scouts took part in 1993 Jamboree On The Air (JOTA) activities, those who did attend spoke enthusiastically about their positive and rewarding experiences.

Twenty groups reported that 855 youth, Scouters and radio amateurs took part. Probably more Canadians participated, based on the number of requests for information we received before the event. JOTA conflicted with Apple Day (as usual), but many groups combined the two events, managing to both sell apples and to tune in foreign stations.

Canadian contacts spanned the world — from Northern British Columbia to South Africa. In total our Scouts reached 24 countries.

The 1st Emerson Cub Pack (Manitoba) enjoyed their first JOTA experience. Discovering that they could track a satellite over Africa really excited the Cubs.

The 2nd Smithers Venturer Company (B.C.) combined JOTA with an open winter camp. This company experienced a rather frustrating radio problem: over the last six years they have

metres from 10.00 hrs through 12.00 hrs. On our second day we tried to participate internationally, but with little luck. We used VE4TTU; for the most part 20 metres was 'flat.' His troop



Wellington District Scouts (Ont.) gather around a radio with operator Jerry Daminto.

noticed that many North American stations tend to "sit on suggested frequencies... instead of using them to make contact and then move on to another clear frequency". Many groups experienced similar difficulties when making contact on common frequencies.

Queen Charlotte Islands District (B.C.) organized a Cub sleep-over on Friday night to give the youth an opportunity to work on their World Cubbing Badge as part of their JOTA activities. They made good use of beach ball globes to locate the countries they contacted. This station found the 21MHz band served their location best.

Guides and Scouts combined their efforts in Timmins, Ontario. They camped out at a United Church youth camp and slept well through the balmy overnight -2° C. They hosted an impressive 144 participants.

The 135th Winnipeg Group (Manitoba) organized several broadcasting locations for local Scouts to visit and join in JOTA activities. During their many years participating in JOTA these Scouts have found the 2 metre band the best to use because especially Cubs do not have the attention span required for high frequency (HF) operation. Experience has also taught these organizers that younger participants find it difficult to understand the sometimes-poor communications on HF radio bands.

"The 1st John DeGraff Scout Troop (Manitoba) participated in JOTA 1993 on both days," says Scouter/radio amateur Ken Barchuk. "Our first day consisted of many local contacts on 2

were not easily discouraged. They returned to the 2 metre band and everyone in the troop had an opportunity to speak on the air.

"Our group decided that long-haul HF was a little like fishing," said Scouter Barchuk. "When they're biting you can't keep them off the hook, but when they're not you can fish all day for nothing." His Scouts gained a good understanding of amateur radio.

A JOTA station set up in the basement of Saint Michael's Church in Thunder Bay, Ont., contacted groups in Canada and the United States. Scouts here made one very unusual 'contact'. During the event, a man in formal dress came into the church basement and told the radio operator that the church organ was broadcasting JOTA conversations to a wedding party meeting upstairs! Needless to say, further JOTA transmissions stopped until after the wedding ceremony! The minister visited the station later and showed considerable interest.

The 1st Fort Henry Troop (Kingston, Ontario) enjoyed some cheerful, cross-border contacts with American groups. One notable incident involved a Scouter and radio operator who tried to set up a 40m dipole with the wire tied around a rock. The Scouter threw the rock over the limb of a tree; the rock landed squarely on the head of a Scout (no injuries sustained).

Scouts, Scouters and operators enjoyed a successful, educational and satisfying 36th Jamboree on the Air. ^

Attention Scouters!

If



You have Scouts or Venturers

Who ...

On August 1, 1995 will be 14,
but not yet 18, years of age

They are eligible to attend
the **18th World Jamboree**
in Holland.

To obtain a registration
package, contact:

Scouts Canada
P.O. Box 5151, Station "F"
Ottawa, Ontario
K2C 3G7

FAX 613-224-5982

The A-B-C's of Camp Planning

from Guy Mandeville

A is for **Applications**. Apply for your camp permit early and send it to the camp coordinator or group committee at least two weeks before camp. Send youth application forms out early to inform parents.

B is for **Booking** the site and **Books** on camping to read, among them Scouts Canada's *By-law, Policies & Procedures* (camping policies and procedures), and the *Fieldbook for Canadian Scouting*.

C is for **Cook** stoves (teach your Scouts how to use and look after them safely), and **Cooking**. Give your Scouts training and practice in preparing, cooking, and cleaning up camp meals.

D is for **Duties**. Explain each clearly, distribute them fairly, and make them fun.

E is for **Enthusiasm** (bubble with enthusiasm), **Early** planning (to ensure the camp's success), and **Environmentally** responsible camp practices.

F is for **Fun** (the essence of good camping), and **Fires** (make sure your Scouts know how to light and extinguish them safely).

G is for **Games**. Plan them with the Court of Honour. The more Scout input, the better the camp.

H is for **Happiness** (the sign of a good camp), **Help** (leaders, parents, Venturers, Rovers), and **Hot** water (makes everyone happy).

I is for **Insurance**. Make sure all campers are registered and know what to do if an accident occurs.

J is for **Junior** leaders who can help in many ways.

K is for **Knots**. Teach them some.

L is for **Lightweight**. Teach Scouts what to take and how to pack.

M is for **Menus**. Let your Scouts plan their own.

N is for **Night**. Use it for star-gazing, night hikes, campfire fun.

O is for **Overshoes** (or boots). Dry feet make happy campers.

P is for **Permit** (know what you need and make sure you have it), **Parents** (keep them informed), and **Program** (build it on the basis of Court of Honour input. Keep it flexible).

Q is for **Quartermasters**. Help where needed, but let them do their job.

R is for **Routine**. You want camp to run smoothly, but be flexible; don't hesitate to change if something special comes up.

S is for **Surprise!** Always keep some up your sleeve to add to the fun.

T is for **Training** in camp skills for both leaders and Scouts, **Tents** (teach Scouts how to pitch, strike, and take care of them in all weather), and **Themes** (they add zest to a camp—let your Scouts think one up).

U is for **Uniform**: a standard camp dress looks smart, especially if you go on a group outing.

V is for **Visitors**. Invite resource people to your meetings to offer special training in camp skills. Invite parents, group committee members, and special visitors to camp to enjoy a campfire, help with services, or provide special programs.

W is for **Weather**. Be prepared to camp in all kinds (rain, high humidity, snow) and enjoy it.

X is for **X-ercise** (early morning workout?) and **X-uberance**.

Y is for **Youth** members. Without youth, Scouting doesn't exist.

Z is for the **Zest** of living through the rest of the year that comes from camping with your Scouts. ^

— Scouter Guy Mandeville is Deputy Area Commissioner, National Capital Region, Ontario.



b&s emblem limited

140 Engelhard Dr., Box 3
Aurora, Ontario,
(Toronto), Canada L4G 3G8

Telephone: 773-7733 Fax: (416) 773-7745

The Crest People

- Embroidered event emblems
- District & Provincial Emblems
- Camp badges & Uniform crests

Highest in quality • Lowest in prices

- Best in service from coast to coast

Really Remote Training!

by Rob Stewart and Heather Chilvers

Over the past few years, with the advent of *Essential Training* (now known as the *Volunteer Recruitment and Development Strategy*), we have been discussing the need for flexible delivery of our training programs. We have re-written the training guidelines to enhance the achievement of this objective. Many councils offer training in a wide variety of formats such as modules, correspondence, and over a series of evenings.

Heather Chilvers, a Scouter in the National Capital Region (NCR, Ottawa), took the challenge of flexible delivery of training to a new high... the high North.

How?

Sheldon Nider, a Northwest Territories Scouter, called the national office and requested that we recruit someone to conduct a Woodbadge I in Pond Inlet, N.W.T.. Heather was recommended by NCR as a trainer who could meet the challenge of travelling to Pond Inlet and present the course on short notice.

Because delivery of a traditional course was not possible, Heather adapted it to meet the needs of local Scout leaders.

The following (excerpts from her report) confirm that we can meet the training needs of our Scouters regardless of their location and number.

AN OPPORTUNE CALL

An opportunity of a lifetime arrived in early November. It began with a phone call from the national office. "Am I available to do some training?... Sure, where?... Pond Inlet?... Where is that?... WHERE?! Doing what?... A Woodbadge Part I for Beaver, Cub, and Scout leaders, plus a little Group Committee training on the side, eh?... Several trainers, right... ONLY ME?... When?... In 8 days?!"

Preparation for such a course usually takes months for several trainers. I didn't want to let the opportunity slip by, so for eight exciting, frantic days I read, prepared sessions, learned all kinds of new information, gathered craft materials from fellow trainers and packed three boxes of supplies, flip chart paper, pens, books, resources and anything else I could think of that a new group with little money and 3,200 kilometres from the nearest Scout Shop, might need.

The participants had two basic questions: "What do we do?" and "How do we do it?"

For the next few days I focused only on these questions. But where do you begin? This question kept rising in my mind.

Because I thought it important that these people felt a part of our Movement, I presented each candidate with a National neckerchief.

After a brief outline of History, Aim and Principles, and Section Overview, we launched into Program Planning. Though the planning process followed a familiar route, some elements of program content surprised me. I had to adapt some program ideas after realizing, for example, that many of our familiar songs incorporated sounds from animals not found in the far north. Working together, we adapted Starwork and Achievement badges to the local culture and habits.

We had the opportunity to practise a planned program and hone delivery skills in front of youth members from the local colony and pack. Great! A live audience.

One evening, we participated in a campfire program (candle in a can on a table in the middle of our circle). We covered songs, skits, games, jokes, spiritual emphasis, Scouters' Five, and presentation ceremonies. We invited spouses and children, and served refreshments. During the campfire, I presented the candidates with their woggles and explained a little of the history of Gilwell.

Time allowed for a group committee session with the Group Chairman. We reviewed the Group Committee Handbook and talked about sponsor responsibilities. Then we viewed the video "Roles and Responsibilities of the Group Committee/Partner". General discussion followed, i.e. "How do we do this in Pond Inlet?"

Eight leaders and the Group Committee Chairman received recognition for their training, however, I learned more than the others. With a polar bear carved by the father of one leader under one arm and a large arctic char under the other, I left for home. Eleven hours and seven airports later, one of my most exciting Scouting experiences ended.

Many thanks to Heather for accepting the challenge to meet the training needs of Scouters in Pond Inlet. Scout trainers, like Heather, show they will "boldly go where no one (or few others) have gone before." ^



Woodbadge participants enjoyed a fun and useful course.

Get Ready For Friends Of The Forest!

Sherry Brayshaw

This September, Beavers and Beaver leaders will start enjoying a much improved and dynamic *Friends of the Forest*.

The Beaver program bases its culture around the *Friends of the Forest* story. In 1992, we began receiving feedback from leaders that the story was no longer meeting the needs of both the children and the overall program. These concerns started an extensive *Friends of the Forest* field review. After assessing ideas and comments, an author produced a trial manuscript incorporating these needs.

A second, third and final manuscript followed after input from the National Program Committee, the National Beaver Network and Scout councils across Canada.

Friends of the Forest is a little book with a huge role. People asked for guidance how to use and apply the book. To ensure leaders and Beavers receive the most benefit from the story, we developed and field tested a *Grown-Up's Guide* to the Friends of the Forest.

What have we ended up with?

To begin, the story is now written for the average 5-7 year old reader. This is a children's book; we hope every Beaver will have their own copy to read at home with their family. The Jones family is still around with the addition of several more characters: "Ringtail" (who uses a wheelchair) and "Sunshine". "Hawkeye" and "Rainbow" are simply grown-up family members without their traditional roles identified.

Originally *Friends of the Forest* was developed before a Beaver culture existed; now the story more closely ties into Beaver program values and ceremonies. Each chapter focuses on at least one theme. For instance Chapter

2 introduces the Beaver Law, while Chapter 3 deals with the Beaver Motto. In Chapter 4 the lightning has changed to "magic light" — feedback showed children were afraid of this part in the original. Often kids feared swim-up occasions, thinking they might be hit by lightning. "Magic light" adds to this friendly fantasy. Encouraged by leaders in the field, we plan to develop Keeco's "magic powers" into future spin-off stories. Chapters 5 and 6 include the whole family talking with Keeco and visiting the lodge. Also, Chapter 6 introduces the opening ceremony in



the story, and contains a much stronger nature-awareness focus. Chapter 7 introduces the Beaver Promise and the closing ceremony. Finally, Chapter 8 ties the swim-up ceremony to the Wolf Cub program and jungle theme.

The Grown-Up's Guide (found in the back of *Friends of the Forest*) highlights the values found in each chapter. It gives suggestions for how to talk about each chapter to Beaver-aged children. As well, the *Guide* provides leaders with program ideas for relating the story to youth in a fun and active way.

Leaders responding to feedback questions suggested a large illustration chart for use when reading the story to

large groups. We developed this idea into the *Story Companion*, a 12" x 18" stand-up set of illustrations that appear in the story.

The illustrations (under the art direction of in-house designer, Rick Petsche, and drawn by artist Mary Moore) are superb and capture the very feelings of a five year old experiencing and discovering nature. Children will want to look through the book just to see the pictures and discover the treasures hidden in each one.

Both *Friends of the Forest* and the *Story Companion* will be available in French and English.

While many people provided input, we would especially like to recognize and thank Brenda Robinson, past National Program Committee volunteer for Beavers. Brenda initiated the review and skillfully guided the initial process through the maze of emotions and meetings involved with such a change. *Friends of the Forest* truly represents what is possible when people work and share together.

Other News

If you have not yet seen or obtained a copy of the *Fun at the Pond* resource book, you are making program planning very hard for yourselves. Almost a thousand copies were sold in the first few months. Leaders find it contains a wealth of "how to" activities keyed to program themes. Check out a copy today at your local Scout Shop!

Future projects include developing new theme books, a national Beaver song book and other pre-packaged theme activities. We will let you know how we are progressing on these exciting projects in up-coming **Leader** articles.

What is our goal? We hope to make being a Beaver leader the easiest and most enjoyable experience possible. ^

— Sherry Brayshaw is a volunteer on the National Program Committee (Beavers).

THRIVING SEA SCOUTS

The 6th Brockville (Ont.) Sea Scout Troop invited the heritage Brockville Infantry Company to visit their troop last November. Sea Scout Andrew Arnott, with period uniform over his Scout uniform, received drill instruction from George McNamara. "Brockville Sea Scouts carry on an interesting program," says First Officer Janet Higgs, "from canoeing to crafts, games to camping, knots to navigation." Photo courtesy of *The Brockville Recorder and Times*.



BEETLING AROUND B.C. Langley District Scouts raised over \$25,000 for local Scouting and a nature reserve after Scouter Bruce Norman and a Volkswagon dealership donated a newly-restored '73 Super Beetle as a fundraising project. Newspapers ran features and soon people all over the lower B.C. mainland were talking about the Scout project. Thanks to Scouter Rob Jones-Cook for sharing.



KNIGHTS OF OLDE Each year Scout knights from the Dartmouth Region, N.S., ride in on trusty steeds from all over the area with their brightly coloured shields and armour to gather and enjoy the annual Fantasy Adventure Camp — based loosely on a medieval Merlin theme. The camp attracts over 230 Scouts. Thanks to Crawford Van Horne.

CUBS CLEAN UP POLICE BANQUET

Cubs from the Saint Paul's Cub Pack (Sussex, N.B.) helped serve (and clean up) dinner at the Law Enforcement Ball last spring. Cubs worked quickly to make sure the 175 guests enjoyed a delicious meal on clutter-free tables. Pleasantly smiling Cubs in the picture clear dirty dishes from the head table. Many thanks to Irene Lewis.





2nd Woodslee Scouts, Ont., enjoyed a fantastic weekend winter camp. Snow and cold temperatures caused no problems. Why? The troop prepared very well before the event by studying winter survival methods, stay warm instruction, and cold weather camping. FUN! Photo: Joseph Spiteri.



ARE WE HAVING FUN YET?! Grinning French-speaking Scouts lashed slats of wood together to make camp furniture during a fall camporee last year. Other activities included hikes, games, and outdoor wood crafts. Thanks to Yvon Lacroix, St. Hubert, Que.



WINNERS CIRCLE Thirty-five excited Cubs from the 2nd Abbotsford Pack (B.C.) enjoyed a "whale of a time" racing their cars during their annual Kub Kar Rally. Here, winning Cubs proudly display their speedy cars. Photo: Debbie Erickson, Abbotsford, B.C.



UPWARD MOBILITY James Fox of the 1st Grande Prairie Scout Troop, Alberta, received a helping hand from an unidentified Venturer at Team Apex at CJ '93. Team Apex was an amazing, physically challenging series of obstacles and balancing activities that attracted the attention of thousands of CJ campers. Photo: Charlene J. Bradley.

FIRE SAFETY

by Glen Hay

Recollections of hair-raising (and singeing) experiences involving Scouts playing with fire, together with a recent letter from a Scouting friend in New Brunswick, prompt me to offer some friendly advice. Fire safety never goes out of style, especially as we plan outdoor activities.

Recently, Keith Barr, APC Scouts/Outdoors for the New Brunswick Council, received a letter from Jim Banks, President of the New Brunswick Association of Fire Prevention Officers. Mr. Banks alerts Scouting to two potentially hazardous situations.

- **Hot Wax and Matches:** Many Scout Troops have traditionally waterproofed wooden matches by dipping match heads into a pot of hot wax. This practice could result in a fire, according to Mr. Banks. A match could easily ignite when dipped in hot wax.
- **Aerosol cans and matches:** Fire Prevention Officers expressed serious concern with misuses of hair spray or other highly inflammable and potentially explosive aerosols. Mr. Banks refers to a dangerous game among some youngsters who create a mini torch or flame thrower by igniting the stream of spray from an aerosol can. "COOL" it may look, but these youth could cause terrible damage to the person holding their can and to anyone, or anything, nearby.

Regarding hot wax and matches, I strongly recommend any groups using this practice **stop immediately**. Our *Fieldbook for Canadian Scouting* describes several, much safer alternatives:

- Our personal survival kit lists "matches, waterproofed with nail polish".
- For hiking safety the *Fieldbook* recommends you carry "matches in a waterproof case" in your pockets.
- Factory waterproofed matches are available in most outdoor and camping stores.

Aerosol cans

The most dangerous item young campers brought to camp, reported one former summer camp director, was not a knife, but aerosol insect repellent. Campers waged "bug spray wars", ending usually with someone sprayed in the eyes. Responsible leaders teach Scouts to buy insect repellent in liquid form, and prohibit or confiscate any bug spray cans appearing at camp.

We must also teach Scouts the dangers of trying to ignite spray from aerosol cans. This makes an appropriate topic for presentations on first aid and home safety. Well-trained Scouts act responsibly, and have opportunities to exert their own brand of peer pressure. Should a Scout's friends intend to try this trick, our Scout could prevent a potentially dangerous and disfiguring accident.

Finally, some general guidelines for campfire safety training:

- Explain risks associated with using camp fuel.
- Demonstrate and have Scouts practise starting campfires without using stove fuel.
- Establish a camp rule to "never use stove fuel for starting a campfire".
- Always monitor campfires and keep them under control.
- Keep aerosol cans away from fires (and preferably out of camp).
- Emphasize each camper's responsibility not to harm himself, others, or the environment.

Above all, keep Scouts busy so they have no time to get into trouble. Boredom creates a ticking time bomb. ^

— Glen Hay works with the National Program Committee (Outdoors).

Follow The Leader

Grant Emblems is Canada's leader in the design and manufacture of the highest quality embroidered crests for troops, district, regional and provincial events, camps and camporees.

- 100 units and over
- Free design help
- Lowest prices
- Prompt service
- Community shoulder flashes and numbers
- Direct embroidery on caps and neckerchiefs
- Baseball caps, jackets, sportswear available

GRANT  **EMBLEMS**

134 Park Lawn Road, Toronto, Ontario M8Y 3H9

PHONE (416) 255-3421 FAX (416) 255-4238
TOLL FREE 1-800-268-2204

70 YEARS OF LEADERSHIP



TRAINING: SEND YOUR IDEAS

We'd like your input on another topic: training ideas. Although several provinces have excellent Outdoor Training programs for leaders, probably many experienced Scouters across Canada have special knowledge, skills, techniques and tips.

Perhaps you "learned the hard way" or from years of experience. Send us your concerns or ideas on environmental protection and outdoor activities. Your ideas could prove invaluable for leaders comparatively new to the challenge of becoming comfortable and "at home" outdoors. Write to Ben Kruser c/o National Program Committee, Scouts Canada, Box 5151, Station "F", Ottawa, ON K2C 3G7.

Introducing Some New Outdoor Badges

by Ben Kruser

As promised in the March *Paksak*, we would like to begin introducing you to some new badges that will be available in September 1995. With spring camp-outs coming, use these badges to stimulate ideas and activities in your pack. The *Fieldbook for Canadian Scouting* is a good reference for planning outdoor activities.

COOKING BADGE

With the help of an adult, do any five of the following:

1. Make some hot oatmeal.
2. Cook a hotdog or hamburger.
3. Use a tinfoil cup, or orange half, and bake a muffin in it.
4. Wrap a potato in tinfoil and bake it in a fire.
5. Boil water and cook some pasta of your choice.
6. Make pancakes or french toast.
7. Make biscuit or bannock dough and cook it on a stick or in a cup.
8. Cook a baked apple, banana or a tinfoil dessert of your choice.
9. Make a campfire treat such as SMOR's or popcorn.
10. Cook a meal of your choice while at camp.
11. Make a meat and vegetable shish-ka-bob and cook it over a fire.
12. Cook an egg.

Cooking Badge Resources

- *The One-Burner Cookbook*, Harriet Barker, Coles Publishing.
- *The Hungry Hiker's Book of Good Cooking*, Gretchen McHugh, Knopf Publishing.
- *Fieldbook for Canadian Scouting*, Scouts Canada.
- *Let's Cook Dutch*, Robert Ririe, Horizons Publishers.
- *Dutch Oven Cooking*, John Ragsdale (North American authority on dutch ovens), Gulf Publishing Co..
- *Dutch Oven*, Chronicled by John Ragsdale, University of Kansas Press.
- *Foodworks*, Ontario Science Centre, Kids Can Press.

HIKING BADGE

1. Know how to take care of your feet for everyday walking through wash-

ing, toenail clipping, wearing clean, dry socks, and using properly fitting shoes.

2. Know how to treat a foot blister, insect bites, hypothermia, overheating, and discuss the importance of getting adequate rest while hiking.
3. Discuss some safety rules for hiking, such as:
 - a) staying with the group and using a buddy system
 - b) keeping to designated trails
 - c) keeping the group together
 - d) having enough drinking water and food
 - e) carrying a first aid kit, whistle and spare clothes.
4. Describe what to do if lost.
5. Know some rules for protecting nature when hiking.
6. Go on four hikes of one to two hours duration, some of which could be in a conservation area or park, around your camp, around your community, or at night.
7. Prepare a nutritional trail mix to eat and share.

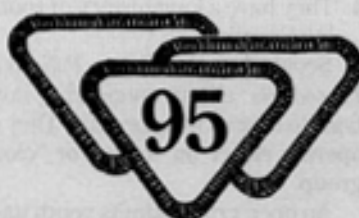

Hiking Badge Resources

- *Fieldbook for Canadian Scouting*, Scouts Canada.
- *Fieldbook*, Boy Scouts of America.
- *The Complete Walker III*, Colin Fletcher, Alfred Knopf Inc..
- National Trail Association of Canada, Box 3098, Stn B, Calgary, AB, T2M 4L6. Has listing of trail clubs across Canada. Produces *Hike Canada* newsletter.

WATERCRAFT BADGE

1. Explain and show the correct way to wear a life jacket or Personal Flotation Device (PFD) while boating.
2. Describe the signs of dangerous weather and water conditions for boating, and what to do when you see them.
3. Demonstrate how to safely enter, change places in, and exit a boat, showing how to move calmly, keep-

ing your weight low and centred. Know how to behave in a boat.

4. Demonstrate the following on land or water:
 - a) Reach out to someone with a paddle or rope.
 - b) While wearing your PFD, curl up in a ball to form the Heat Escape Lessening Position (HELP) to keep warm in the water.
 - c) With a small group all wearing PFD's, huddle together into the HUDDLE position to keep you and others warm in the water.
 - d) Rescue breathing.
5. Know the importance of staying with your boat if you fall out or tip over.
6. With a buddy or adult, launch a boat and travel in a straight line for 50 metres, turn and come back.

Note: Direct contact (human-to-human) is not required for Cubs practising rescue breathing.

Watercraft Badge Resources

- *Song of the Paddle*, Bill Mason, Key Porter Books. Excellent canoeing reference.
- *Path of the Paddle*, Bill Mason, Key Porter Books. Excellent canoeing reference.
- *CanoeCraft*, Ted Mavers and M. Mohr, Canadian House Publishing.
- Canadian Recreational Canoeing Association, 1029 Hyde Park Road, Suite 5, Hyde Park, ON, N0M 1Z0. Leading Canadian association on canoeing. Can provide information on books, canoe clubs, river clean-up campaigns and safety standards. Produces *Kanawa* magazine.
- Canadian Power and Sail Squadrons, 26 Golden Gate Court, Scarborough, ON, M1P 3A5. Leading Canadian association for training in recreational power boating and sailing.
- The Canadian Red Cross Society — *Small Craft Safety*. Contact your local Red Cross Chapter for information.
- Canadian Coast Guard — *Safe Boating Guide*. Contact local station for information.
- Canadian Coast Guard — *Boating Handbook*. Contact local station for information.
- Canadian Coast Guard — *Safe Boating & Personal Flotation Devices*. Contact local station for information. ^

Faith and Kids: Scouting Hits the Spot

by Warren McMeekin

Churches and faith communities need kids: kids need a faith community! Where does Scouting enter this picture? Some faith groups create their own youth activities or use various national youth curriculae. More than 2,000 Canadian religious institutions use Scouting's program.

Scouting brings faith communities various pluses, including our track record of almost 90 years. Steady growth around the world means Scouting now involves 16 million youth in over 150 countries, and over 180,000 in Canada. For faith communities considering our programs, Scouts Canada provides important services:

- Program development and evaluation.
- A training program for leaders.
- Scouts Canada ensures our programs contribute physical, intellectual, social and spiritual challenges for our youth.
- Scouting provides support resources.

Duty to God remains every Scout's duty. This lays our foundation on which a faith community may build. When invested, each member makes a promise to love God, or love and serve God, or assume duty to God.

The first and perhaps most important contribution a church sponsor makes is to select religious leaders from their active congregation. Such leaders will provide strong examples

and genuine interest in the congregation's religious education program. A fellowship maintains strong influence on leadership style and quality in this way.

Secondly, the spiritual adviser (minister, rabbi, etc.) should visit Scouting sections as often as possible, and design their meetings' devotional program.

Thirdly, a sponsoring group may arrange Scout parades at regular intervals, allowing their complete Scouting group to attend a religious service.

Fourthly, our Religion in Life program encourages everyday interest in the sponsoring church or other faith community, their history and doctrine. This curriculum also advocates Scouts' participation in useful service projects.

Religious groups are excellent sponsors for our programs because:

1. Congregations provide religious content to our adaptable programs, and take responsibility for religious education.
2. They can mobilize people of good moral character as leaders.
3. Parents have confidence in their faith communities.
4. They have a long history of sponsoring Scouting.

Scouts Canada's *Bylaw, Policies and Procedures*, allows sponsoring institutions to restrict membership. They may operate either an "open" or "closed" group.

An open group admits youth unconnected with the sponsoring organiza-

tion. A closed group limits membership to youth who are also members of their sponsoring organization. Scouts Canada strongly advocates open groups. Our rationale includes:

- Natural "buddy" relationships come from living next door, down the street, or sitting in the same class at school. Both Scouting and sponsoring organizations will want to encourage and preserve these natural friendships.
- Worldwide, people desire to bring members of different faiths closer together. By mixing Scouts from different religions we might teach them respect and understanding for other faiths and religious customs.
- Faith communities know that indifference in the home, broken homes, and other unhappy conditions, have resulted in many thousands of youth across Canada having no religious connections or guidance in their spiritual development.

Scouting attracts youth. Their first contact with a religious body may be through our program. Thus, Scouting can often introduce youth members to religious congregations and their teachings.

Scouting can provide youth a bridge between faith and the world around them. Kids need faith: faith communities need kids. Scouting stands at the crossroads. ^



WOVEN SHOULDER FLASHES

superior quality • colourfast • woven in England by Cash's

STYLE 18

- 36 labels @ \$22.00
- 72 labels @ \$26.00
- 108 labels @ 30.00
- 144 labels @ \$38.00



LETTERING :

- blue
- green
- black
- brown

TAPE COLOUR:

- white

12mm (1/2) wide

3RD SUDBURY PACK

12TH KELOWNA TROOP

NAME TO BE WOVEN

- 24 letters and spaces

SHIP TO:

Name: _____

Address: _____

City/Town: _____

Province: _____ Postal Code: _____

Phone: () _____

Send Cheque or money order for total:

(please add 7% G.S.T.), Ontario residents must also add 8% provincial sales tax.

MAIL TO: H.A. Kidd and Company Limited
2 Mark Street
Toronto, Ontario M5A 1T8
attention: Scout Labels

(please allow 3 - 4 weeks for delivery)

• • • You may photocopy this ad • • •

Kinus '93: A Great Success!

By Howard Osterer

How can we increase the low Jewish Scouting presence throughout Ontario?

That was the question representatives from Ottawa's 39th Henry "Hank" Torontow Cub Pack (Ont.) discussed when they met in late 1991. Although Ottawa has a very active Jewish program with over 100 participants, in large centres such as Montreal and Toronto Jewish Scouting involvement is generally low.

Our brainstorming resulted in Kinus '93, the first gathering of Jewish Scout and Girl Guide youth from Central Canada (June 3-6, 1993).

The four day outdoor camping and sightseeing experience involved a Jewish component which would interest youngsters from all backgrounds.

Some of the weekend highlights included: an Ottawa River cruise; tours of the Bytown Museum, National Arts Centre, and National War Memorial; and a rickshaw ride through Byward Market. During a special tour through the Parliament Buildings, Kinus participants met the Honourable Herb Gray.

Our touring wound up at Rideau Hall, the home of His Excellency, the Governor General of Canada Ray Hnatyshyn and Mrs. Hnatyshyn, who are, respectively, Chief Scout and Honourary President of Girl Guides of Canada. Aide-de-Camp Bruce Howie accepted the official Kinus '93 cap on behalf of the Hnatyshyn's.

A warm and welcoming Friday night and Saturday program greeted Kinus participants. Planners hoped that the program would end with an outdoor Havdalah service, however, rain forced everyone indoors where they enjoyed a cosy campfire in a gym. Scouter Tom Caplan and the Young Israel Synagogue (Ottawa) hosted the Sabbath program on Saturday.

During our Sunday Scouting Fair youngsters participated in a variety of crafts and activities: silkscreening Kinus '93 logos onto T-shirts; using a ham radio; working on leather crafts; sharpening a camp knife safely, guided by Scouter George Dunne (115th Sea Scouts, Ottawa); making plaster casts of Lord Baden-Powell; and badge trading.



Tent frames can sometimes be tricky to set up. Photo: Cliff Fielder.

The Ottawa Jewish Community Centre board hosted the final farewell barbecue — an all-you-can-eat-feast. Kinus participants consumed over 350 hamburgers and 400 hot dogs!

Was all the work worth the effort?

One Cub gave his opinion: "Do we really have to go home now? I'm really having a lot of fun here."^

— Howard Osterer works with the 39th Henry ("Hank") Torontow Cub Pack and Scout Troop.



Your Problem:

FUND RAISING

The solution:

PEN PAK

You only pay for
packs you sell



If you are planning a fund-raising campaign, the Carrier Pen Pack, model P3Z is your answer. The model P3Z consists of 3 MULTICOLOURED BARREL BIC pens (medium point, blue ink) inserted in an imprinted vinyl case. You pay only 85 cents per pack. Price includes imprinted message of your choice on vinyl case,

GST and shipping charges. Suggested sale price of \$2.00 per pack leaves you a profit of over a 100%. There is no risk involved since 6 weeks after date of invoice you pay only for packs sold and return any left-overs to us. Minimum order is 600 packs.

Also available:

3 BIC white barrel pack medium point: includes 2 blue ink and one red ink. You pay 72 cents and sell for \$1.50

4 BIC white barrel pack medium point: includes 2 blue ink, one red ink and one black ink. You pay 96 cents and sell for \$2.00.

To order simply complete the coupon and mail or fax to Carrier Pen.

Please ship us Carrier Pen Paks (600 minimum)

P3Z pack 3 BIC pack 4 BIC pack

Six weeks after date of invoice, the buyer agrees to pay for the packs sold and to return the left-overs to:

CARRIER PEN CO. LTD.

70 Assumption Blvd. West, P.O. Box 214, Joliette, Que. J6E 3Z6.

Toll free 1-800-267-1338 Fax: (514) 759-0055

organization

address

city

prov. p. code

tel. fax

name

title

signature

copy to be imprinted

Handy Treasures To Remember

Rare gems of wisdom present themselves at the oddest of times. Always share them before they drift away from your memory. Here are a few of the best.

Wet hiking boots

In the outdoors wet hiking boots plague all of us at some time. Not only are they annoying (and drying is difficult), but wearing wet boots can seriously affect your feet.

The quickest drying method involves collecting enough pebbles to fill them. Heat the pebbles in a covered pot or pan. Take one or two pebbles and test them against the foot liner. If they start melting it STOP; otherwise fill the boots half full with the pebbles and slake. Replace them when they cool with more warm-hot pebbles. Repeat this process until your boots dry. It requires time but a lot less than natural evaporation.

Going winter camping? Start your day off with warm pebbles in your boots. What a cosy treat for your feet!

Easy trail gourmet desserts

Everyone likes camping with freshly baked desserts. (Is your waist line obvious proof?!) Compact campstove ovens take up too much space. They usually stay at home when weight considerations need attention.

Is there a solution?

Buy an aluminium (or tin) ring cake pan — the same ones used for angel food cake. These normally hold about two litres of batter. Even on the trail you can create a delicious cake with extraordinary texture with your light weight campstove.

When making a cake, simply mix your favourite dry ingredients together, add the necessary liquids and pour into a previously greased cake pan. Be sure to position the pan's centre hole over the middle of the stove's burner.

This allows the heat to rise evenly. Put a pot lid or frying pan on top of the pan as a cover. Make sure it doesn't block the top of the angel food cake pan centre tube.

Prepare a good bed of hot coals when cooking over an open fire. Place the pan over the coals on three or four well placed rocks with a 4cm gap between the base of the cake pan and the coals.

Whether cooking over a fire or stove, turn the pan about every five minutes. Shelter the stove and pan from the wind to avoid uneven heating.

The cake will cook faster than in a normal oven. Expect the baking time to stretch well beyond that of a conventional oven if you keep lifting the lid to admire your creation.

Once you've mastered cake baking, think of all the other delicacies you can try. Why not plan a baking contest for your next camp? One last hint: shelter the stove and pan from the wind or the heat will cook unevenly.

Responsible trail blazing

Have you seen unsightly trail markers left behind by others, even in wilderness areas? Many are bright plastic and permanently fastened to trees with wood or metal. Other thoughtless trekkers still hack bark off the trees.

Past practices are completely inappropriate now. Such trail-blazing activities are not only illegal in many places, but also attract substantial fines.

If you need to mark your trail, here is a great idea.

Make yourself a biodegradable marker. Simply mix flour, water, salt and a little starch together and stir to a sour cream consistency. Use food dye to change colours, although white is excellent. Brush this "paint" on anything along your trail. After two or

three rainfalls it will disappear. During dry periods it will provide a welcome treat for insects and birds.

Coffee making

Many Scouters are coffee-holics. For them the practice of light weight, no-trace camping bares considerable costs! Some campers throw coffee grounds into a pot of boiling water. This doesn't give the taste they want. Here is a neat idea for a trail coffee percolator.

Bring along a small metal strainer sized to fit over a two litre sauce pan. In it place a coffee filter made from two or three layers of cheese cloth. (Prior to departure sow this into a small pad at home.) Place the coffee grounds in the cheese cloth lined strainer and then hold it over the sauce pan. Pour boiling water over the grounds.

About two or three level tablespoons of coffee per 250ml water makes an excellent brew. Scatter the used, biodegradable coffee grounds to the wind well away from established campsites. Use the metal strainer to prepare other food items; rinse the cheese cloth filter and use over and over.

Foot odour blues

Has the strong smell of someone's feet disturbed an otherwise pleasant ride home after a long hiking trip? Your best reaction is to try preventing it.

Every night after hiking encourage everyone to soak their feet in a solution of 25ml of vinegar mixed with four litres of water. This will help toughen and sooth feet, cut down on foot odours, as well as provide a good time to examine feet for blisters, etc..

Dust feet with foot powder before starting out each day. Baking soda makes a good, non-commercial substitute. Wear light-weight wool or cotton socks. X

OOPPPS!

The Eh, Canadian Provincial Moot "Rovering From Sea To Sea" begins **August 26**, 1994, and NOT August 16 as we announced in the February *Venturer Log*.

Important Note

Firearms Control Law

National program directors are clarifying requirements of the new Firearms Control Law. Watch for further details in next month's *Venturer Log*.

Personal Hygiene: *Tips and Projects*

by Colin Wallace

Wallace's *Dictionary of Scouting Terminology and Jargon* defines hygiene as "a cleansing ritual using soap and water (and occasionally bleach) to ward off salmonella, botulism, halitosis, athlete's foot, body odour and dandruff."

Personal hygiene is one of those subjects everyone would rather not discuss because it's so ... well ... personal. But, if you have ever sat in the same room as 23 sweaty Scouts who've just finished an intensive game of murderball, you will recognize when a teachable moment for personal hygiene has arrived.

Follow these guidelines when addressing this delicate subject.

Handle your discussion with sensitivity. Never single anyone out from his/her friends. For example, don't begin by insisting that Bruce take a shower every month whether he needs it or not!

Be subtle. Involve your troop in activities that lead them to the inevitable conclusion that they will actually feel better if clean.

Suggest that each Scout bring along a face cloth and hand towel, instead of the usual large bath towel, to your next camp for a scrub-down. These are smaller and lighter in your pack, dry faster than a large towel, and also don't require a basin.

Just pour warm water onto the cloth: instant micro-bath. Wipe and scrub every body part you can reach working from the top down. Scrub dry with the hand towel.

When you've convinced your mob that they won't die if they wash more often, encourage them all to don swim suits one morning at camp so they can bathe in the dew-covered grass. B.-P. recommended this bathing method. At winter camp, try bathing briefly (very briefly!) in fresh snow.

Reluctant to start your day with such vigour? Why not build a sauna? This project combines pioneering and fire-building skills.

Fun project ideas

Try approaching this subject as a science project.

How? Capture your Scouts' interest by making soap leaves. Soak a paper towel in a half-and-half solution of water

and liquid soap. (You can make your own liquid soap from remnants of bar soap.) Lay out the towels to dry in the summer sun, then cut them into leaves of convenient size. Moisten each soap leaf before using.

While your Scouts are having fun with soap, have a little fun yourself. Paint a bar of soap with several coats of satin-finish shellac to prevent it from lathering. Replace the bar in its original wrapper and give it to some unsuspecting Scout!

Try a 
grass bath!



Why take along a whole toothpaste tube on your next backpacking trip? Get your Scouts to fill a small plastic container with a mixture of baking soda and table salt. Not only is it an effective and lightweight tooth-cleaner but it's also non-polluting.

Try building a camp shower. Convert large plastic soft drink bottles into individual shower baths by perforating the base with an awl's red hot tip. The bottle releases a spray of water only when you loosen the airtight screw cap. You'll need a funnel to get the hot water into the bottle; make one from a smaller, cut-down plastic bottle. Add a touch of realism: install a tin can telephone that rings when anyone uses the shower!

Each patrol can make a hand-washing station for the kybo from an empty bleach bottle, a golf tee, and some string. Use the golf tee to plug a single small hole in the side of the bottle near the bottom. Fill the bottle with water treated with a half cup of bleach, and hang it near the kybo. Scouts leaving the kybo simply need to unplug the bottle, rinse their hands in the stream of disinfecting water, re-plug the bottle, and air-dry their hands.

Looking for more ideas?

Ask each patrol to compile a list of ingredients for a personal toilet kit. Compare the lists, then invite patrols

to pare down their lists to the bare necessities to reduce weight for a backpacking trip.

Some Scouts will try to reduce their toiletries to just a toothpick and a scratching tool. Remind them that career opportunities for cave-dwelling shepherds are limited these days.

Early pioneers did not neglect their hygiene. The Readers' Digest book *Back to Basics* (page 341) gives recipes for old-fashioned, natural ingredient shampoos. While your Scouts try making shampoos, they could also assemble a kit containing small plastic bottles of liquids: soft soap, shampoo, hand lotion, toothpaste, shaving gel, and insect repellent.

With a kit like that your Scouts will smell like a flower garden.

Just remember the story about the Scout who invented a new deodorant. When he sprayed it on, he became invisible? X

— Scouter Colin Wallace is ADC (Training), Greater Toronto Region, Ontario.

Kub Kar
SuperTimer
with
Klass.

- PC (or compatible) computer-based
- Wired, tested, guaranteed
- Easily installed
- Available for up to 7 lanes — handles any track
- Lane results in order of finish (to .0001 seconds)
- Provides the fairest rally with RaceManager option
- The most complete, most accurate system available

No Kidding!



dbc · mifco
90 Fleet Street
Portsmouth NH 03801
(800) 654-2088

For Service to Scouting

compiled by Cheryl Dinelle

In this issue, we are pleased to announce the names of people in Scouting who have been recognized for gallantry and service between September 1, 1993 and January 31, 1994. Awards made after January 31, 1994 will be announced in a fall issue of **the Leader**. We have also initiated a new award, presented provincially, called the Award For Fortitude.

AWARD FOR FORTITUDE

(for youth and adult members of Scouts Canada who, despite physical or mental impediments to their involvement, have made a significant contribution to the Movement)

Edd Banman, Prince Albert, Sask.
Brian Dark, Winnipeg, Man.
Jared Fisk, Sparwood, B.C.
Graham Gill, Willowdale, Ont.
Charles Hallett Sr.,
Grand Centre, Alta.

Adam Lloyd, Prince George, B.C.
Aaron Powell, Burlington, Ont.
Harvey Sanderson, The Pas, Man.
Stephen Waines, Fort Erie, Ont.

CERTIFICATE FOR GALLANTRY

(for gallantry with slight risk and worthy of recorded commendation)

David Still, Scarborough, Ont.
Ronald Tannas, Marwayne, Alta.

CERTIFICATE FOR MERITORIOUS CONDUCT

(for meritorious conduct worthy of recorded commendation)

Sean Boyer, Saint John, N.B.
Justin Cantwell, Grande Cache, Alta.
David Harvey, Winnipeg, Man.
Kenneth Hoose, Ilderton, Ont.
Ronald Last, Richmond, Ont.
Robert Paterson, Grande Cache, Alta.
Justin Zadworny, Man.

BAR TO SILVER ACORN

(for further especially distinguished service to Scouting)

Reginald Wyer, Baddeck, N.S.

SILVER ACORN

(for especially distinguished service to Scouting)

Keith Best, Kelowna, B.C.
Charles Dozois, Anjou, P.Q.

Cathern Drury,

Dollard Des Ormeaux, P.Q.
Ali Eason, Winnipeg, Man.
Miguel Fernandes, Richmond, B.C.
Vincent Goldsworthy Sr.,
St. Catharines, Ont. (Posthumous)
Peter Haggarty, Calgary, Alta.
David Hamilton, Nepean, Ont.
Robert Kane, Saint John, N.B.
John McGimpsey, Anjou, P.Q.
Wilfred Stanbrook, Dartmouth, N.S.
John Sutherland, Halifax, N.S.
Louise Van Grol, Vancouver, B.C.
Raymond Wallace, Kamloops, B.C.
Dan Wiwchar, Winnipeg, Man.

BAR TO MEDAL OF MERIT

(for further especially good service to Scouting)

Elise Harris, Woodstock, Ont.
Evelyn Hunt, Victoria, B.C.
Ray Paul, Spruce Grove, Alta.

MEDAL OF MERIT

(for especially good service to Scouting)

Edward Aitken, West Hill, Ont.
Gary Andrews, Lantz Hants Co., N.S.
Ken Arndt, Regina, Sask.
Kenneth Arsenaull, Winnipeg, Man.
Brayn Babiarz, Scarborough, Ont.
Ted Bevan, Streetsville, Ont.
Wayne Biette, Regina, Sask.
Wally Bonner, Toronto, Ont.
Marilyn Brandal, Lr. Sackville, N.S.
Daniel Brownsberger, Calgary, Alta.
Jack Bulpit, Oromocto, N.B.
Gordon Cameron, Roland, Man.
Terry Campbell, Maple Ridge, B.C.
Brian Carr-Harris, Victoria, B.C.
Thomas Childs, West Hill, Ont.
Arthur Chisholm,
Enfield Hants Co., N.S.
David Clarke, Dartmouth, N.S.
Derek Connolly, Edson, Alta.
William Cosburn, Calgary, Alta.
Ross Cowan, Fort Qu'Appelle, Sask.
Patricia Cowell, Mississauga, Ont.
Warren Crawford, Surrey, B.C.
John Crook, Grand Centre, Alta.
Brian Cumming, Calgary, Alta.
George Custance, Winnipeg, Man.
Malcolm Davidson, Carvel, Alta.
Ken Dewar, Pointe Claire, P.Q.
Anthony Elliott, Callander, Ont.
Debra Farrer, Kenora, Ont.
Marianne Foster, Dartmouth, N.S.
Leslie Glover, Mt. Brydges, Ont.
Art Gordon, Revelstoke, B.C.
Carol Graham, Barrhead, Alta.

Robert Graham, Kitchener, Ont.
Thomas Hiscott, Toronto, Ont.
Bernd Hohne, Winnipeg, Man.
Alfred Huggins, Port Perry, Ont.
John Hughes, Blockhouse, N.S.
Mary Hughes, Blockhouse, N.S.
Donald Hull, Bracebridge, Ont.
John Humphreys, Winnipeg, Man.
Barbara Jasper, Woodstock, Ont.
Mimi Johnson,

Windsor Junction, N.S.
Raymond Kane, Renfrew, Ont.
Don Kervin, Douglstown, N.B.
Allen King, Calgary, Alta.
Wolf Kutschke, Knowlton, P.Q.
Raymond Lachowitz, Kronau, Sask.
Calvin Ladd, Komoka, Ont.
Ian Lovie, Medley, Alta.
Robert Mabey, East Riverside, N.B.
Clara Maltby, Revelstoke, B.C.
Elvy Maurice, Coquitlam, B.C.
Curtis Maxwell, Calgary, Alta.
Doug McCaffery, Brossard, P.Q.
Edmund McFaul, Lachute, P.Q.
Brian McIvor, Calgary, Alta.
Bill McWilliams, Winnipeg, Man.
Aldene Meis Mason, Regina, Sask.
Lionel Mongrain, Kenora, Ont.
Douglas Moore, New Minas, N.S.
Charlotte Mullen, Winnipeg, Man.
Brenda-Deane Nichols,
St. Albert, Alta.

John Nielsen, Stony Plain, Alta.
Lori Palfy, Fort St. John, B.C.
Ron Parsons, Kirland, P.Q.
John Pharoah, Scarborough, Ont.
Peter Pincombe, Kenora, Ont.
James Potter, Downsview, Ont.
Jack Prodanuk, Winnipeg, Man.
Ross Purse, Regina, Sask.
Joseph Rahal, Thunder Bay, Ont.
Lillian Rhodes, Roxboro, P.Q.
James Robertson, Halifax, N.S.
Ronald Saxby, Regina, Sask.
Shirley Scattolon,
New Waterford, N.S.

Robert Shaw, Fredericton, N.B.
Joyce Sisson, Surrey, B.C.
Edwin Slater, Don Mills, Ont.
Kenneth Smith, Calgary, Alta.
Ken Struthers, Kelowna, B.C.
Lynne Swanson, Sparwood, B.C.
Anne Temreck, Surrey, B.C.
Jack Tipler, Callander, Ont.
Mark Tysiaczny, Winnipeg, Man.
John Waters, Burford, Ont.
John Whitehead, Lethbridge, Alta.
Robert Whitwick, Chilliwack, B.C.
Chuck Young, Thompson, Man. ^

SCOUTER'S 5

As a homemade Scout's Own, I asked all our Beavers to complete the following sentence using their own thoughts: Thank you God for _____.

Then I gathered all the thoughts together (their exact words) and used it as a prayer. Wow! Did the Beavers ever pay attention!

Thank You God For...

Cubs and bugs
 CD systems and rock and roll
 Scouts and Beavers and Cubs
 Cabins and food
 Water fights and campfires
 Mom and dad, love and friendships
 Life, animals and entertainment
 Friends, food and water
 Family, money and the whole earth
 Birds, the sun and the world
 Food and toys
 Family and friends
 Sun and rain
 The air we breathe
 Water, sun and us

Thank you for the food we eat and the
 Creatures we enjoy looking at.
 Trees and nature and this place.
 Schools, jobs and clothes.

Thank you God for... **Everything.**

— Pat Brethauer (27th Beaver Colony,
 Sarnia, Ontario)

Christ has died,
 Christ is risen,
 Christ will come again!
 — Anglican chant.

Scouter's 5 Minutes, p.719.

Apr.'94

SONGS

Akela We're Assembled Here

(Tune: Auld Lang Syne)
 Akela we're assembled here,
 Around the Council rock,
 About you glance and you will see
 The finest of your flock.

Our promise once again we make
 That we will "Do our best"
 Right loyally we'll hunt with thee
 Thro' North, South, East and West.

Pack Up Your Dinner

(Tune: Pack Up Your Troubles)
 Pack up your dinner in your haversack
 And hike, hike, hike.
 Take all you want upon your own strong back
 And wander where you like.
 Leave the road to the motor cars,
 the sidewalk to the bike.
 And pack up your dinner in your haversack
 And hike, hike, hike.
 — Australian Scout.

This Land Is God's Land

We must take care of
 The world we live in
 We must not waste what
 Our God has given,
 We need clean air, soil, and water too.
 God made this land for me and you.

(Chorus)
 This land is God's land,
 We must respect it,
 We must protect it,
 And not neglect it.
 If we take care of,
 What God has given,
 This land will stay for me and you.

Songs, p.99

Apr.'94

CUSTOM EMBROIDERED CRESTS

Serving the Scout world

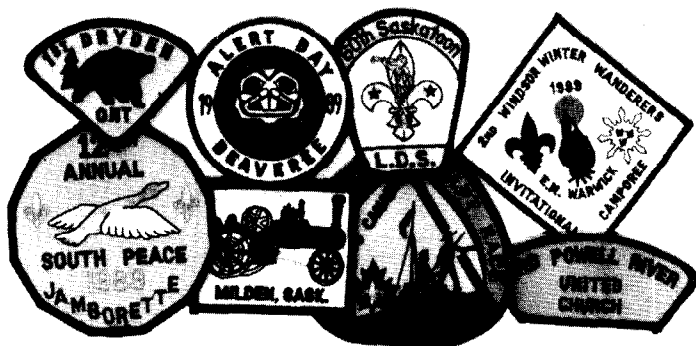

Custom-made
 ENAMELED PINS

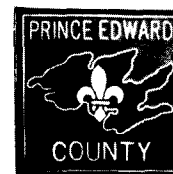

CHAMPION CREST COMPANY

REASONABLE PRICE
 FINE QUALITY!

P.O. BOX 39056, POINT GREY, VANCOUVER, B.C. V6R 4P1
 TEL: (604) 874-0632 FAX: (604) 874-0522

ON-TIME DELIVERY
 BEST SERVICES!

We breathe the fresh air,
We feel the sunlight,
God made clear water,
To make things just right,
We need the plants and
The animals too.
God made this land for me and you.
(Chorus)

Pollution poisons,
Our air and farmlands,
It's not from nature,
But from our own hands.
The health of our world,
Rests on what you do
God made this land for me and you.
(Chorus)
— from Patrick Martin, 1st North Gower/Kars
"A" Pack, Ontario.

Mowgli

(John Brown's Body)
The Cubs were at the Council Rock
To show themselves to all,
But they were interrupted by
The wicked Shere Khan's call;
He wanted back the little boy
Who Raksha called her own,
But this was not to be.
For suddenly the wise Baloo
Let out a mighty roar;
"I will teach the little boy
To know the Jungle Law!"
Bagheera said he'd pay the price
For baby Mowgli's sake,
So the Man Cub joined the pack.
— Thanks to Shirley Bergsma.

Songs, p.100

Quiet Thoughts

"Service is the rent we pay for our room on earth." — King George VI

Those who bring sunshine into the lives of others cannot keep it from themselves.

"The difficult is that which can be done immediately; the impossible is that which takes a little longer." — Santayana.

Every noble work is at first considered impossible. — Thomas Carlyle.

Every time you put across a new idea, you'll find ten people who thought of it before you — but they only thought of it. — from Scouting in New South Wales.

There's almost no limit to the amount of good someone can do if he doesn't care who gets the credit.

Education must be positive, not negative; active not passive. — B.-P.

Goodwill is God's will. — B.-P.

Love's concern is with the revival of the unfit, rather than the survival of the fittest.

He whose name is Love will send the best.

Scouter's 5 Minutes, p.720.

Be a the leader Reader!

Leading the way
10 times a year!

Mail to: Box 5112, Stn F
Ottawa, ON K2C 3H4

Subscription rates:

Registered Adult Members Scouts Canada \$7.49 / year (Includes GST)
Others in Canada \$10.70 / year (Includes GST)
Outside Canada \$15 / year

Please send me the Leader. I enclose my cheque (money order) for:

1 year 2 years new subscription advanced renewal

Name _____

Address _____

City _____

Prov. _____ Postal Code _____

the leader*

G.S.T. Reg. No. R100 794528

ANNOUNCING: THE "HELP FIND A NEW NAME FOR TREES FOR CANADA" CONTEST!

We're looking for a new name for *Trees for Canada*, and we need your help.

Send us your suggestion for a new name. If your suggestion is selected as the new name, you could win an **all expenses paid trip for two** to the special planting of the 50 millionth tree in the spring of 1995 (time and location to be determined.)

You could also get to participate in the planting of this very special tree!

WHY A NEW NAME?

Recent surveys show that many members of the general public know about *Trees for Canada*. The problem...many of them do not know that *Trees for Canada* is a program of Scouts Canada.

Part of this problem lies in the existing name. We need a new name that will help link our highly successful tree planting program to Scouting.

In 1995 we will plant our 50 millionth tree. What a perfect time to launch our new name!

ARE YOU UP TO THE CHALLENGE?

Every contest needs some rules, so here we go.

- 1) The contest is open to all registered youth and adult members of Scouts Canada (Scouts Canada staff members are not eligible).

- 2) Submit your suggested new name in either English or French.
- 3) Each entry must be sent in on the attached card or a photocopy of the card.
- 4) Only one suggested name per entry. You may enter as many times as you like by photocopying the card.
- 5) Only one entrant's name may appear on each entry form.
- 6) Entries must be received by **June 1, 1994**.
- 7) If more than one entrant suggests the winning name, the contest winner will be decided by date of receipt of entry. If more than one winning entry arrives on the same date, a random draw will be held to determine the winner.

The selection of *Trees for Canada's* new name and the winning entrant will be announced in the August/September issue of the *Leader* magazine.

Send your entries to: Scouts Canada
Communications Service
Box 5151
Station "F"
Ottawa, ON
K2C 3G7

Don't forget. Entries must be received by **June 1, 1994**.



**dress crest
embroidery
company**
LIMITED

Phone (416) 789-2893
Fax (416) 789-9076

116 TYCOS DRIVE
(REAR ENTRANCE)
TORONTO, ONTARIO
M6B 1V9







- FIRST QUALITY WORKMANSHIP.
- CAMPOREE, DISTRICT, PROVINCIAL AND NATIONAL EMBLEMS.
- FREE DESIGN SERVICES.
- SMALL AND LARGE QUANTITIES.
- DIRECT EMBROIDERY FOR BASEBALL CAPS AND SPORTSWEAR.
- SPORTSWEAR AND BASEBALL CAPS ALSO AVAILABLE.

'YOUR ONE STOP EMBROIDERY SHOP'

High Sierra: Passport to Adventure

by Bob Boreham

Scout Shops coast-to-coast now carry selections from internationally respected High Sierra, makers of internal frame backpacks, fanny packs, rucksacks and sport gear bags. High Sierra is committed to thoughtfully designed, long lasting products that perform well in the wilderness. The company selects fabrics for their strength, resilience and durability. They add heavy-duty zippers and hardware, and design details to enhance appearance as well as improve performance.

Supply Services believes the six High Sierra products we offer contain the strength, features and dependability that Scouters everywhere look for. Superior features include: straps and handles padded and contoured for comfort; stress points reinforced for extra strength; top quality 600 denier Duralite and 420 denier Oxford nylon in forest green and mulberry colour combination; and durable, quick-release Fastex hardware. High Sierra backs-up its products

with a lifetime warranty against defects in workmanship and materials.

The **deluxe fanny pack** (with room even for a video camera) features a large capacity pouch, an easy-access front accessory pocket, and adjustable suspension straps designed to compress the loaded pack onto your hip to ensure comfort and stability.

The **expandable fanny pack** features an expanding main compartment and three smaller ones for maximum storage. A pleated front pocket allows easy access to small items such as wallets or keys. An adjustable waist belt and reinforced side wings with zippered pockets ensure a comfortable fit.

The **sport gear bag** boasts an extra-large compartment, mesh pockets, and a unique horseshoe zipper opening to allow easier bag packing/unpacking. Large front pockets store a multitude of accessories. A special mesh pocket under the main lid holds wet gear, shoes or other appropriate items. The bag also

has a reinforced bottom panel and a detachable shoulder strap.

Supply Services offers three different outstanding models of **internal frame packs**, all with large main compartments. Side pockets provide extra storage for water bottles and similar accessories. The light-weight internal aluminum frames are strong and durable. Padded, contoured shoulder straps, reinforced side wings and padded back and hip belts guarantee maximum comfort.

Visit your local Scout Shop to see these top quality High Sierra products for yourself. Prices range from \$14.95 (for the expandable fanny pack) to \$129.95 (for the internal frame backpack).

We have devoted considerable time and research effort to guarantee a high-quality, affordable product that will withstand the rigours of Scouting activities. These High Sierra packs exceeded our expectations.

Scouting and High Sierra — your passport to adventure! ^

We're Reaching New Heights!

Whatever your endeavour, High Sierra is your passport to adventure. From the All Sport Gear Bag to the Expandable Fanny Pack, these bags are constructed for light weight and super strength with self-repairing nylon coil zippers. Each bag is meticulously crafted with the finest materials and hardware, and has a lifetime warranty. From \$14.95 to \$129.95.



Check your local Scout Shop for these bags and other fine outdoor gear.



How Cosy Is A Quinzee?

The January *Leader* article about quinzee building inspired my son and me to build a snow shelter in our back yard.

I grew up in Scotland where there is little snow. As a Scout leader, this year I was preparing for my first winter camping trip, full of apprehension.

The night we slept outside in our quinzee, the temperature dropped to -25°C, with a windchill of -41°C. We used a candle inside for light and heat. In our cold-weather sleeping bags we spent a good night: comfortable and cozy. When we woke next morning the temperature in our shelter was *much* warmer than outside.

Our initial apprehensions about winter camping proved unfounded. The quinzee was relatively easy to build, forgiving if you don't do a good job of scooping out snow, and was relatively warm and snug, even in bitter temperatures. With proper planning and thought, cold-weather camping is fun!
— *David Green, Kanata, Ont.*

The Survival Whistle

As usual I started reading the January issue of the *Leader* as soon as it arrived.

The article "A-B-C's of Survival" was good except you missed one very important piece of gear — the whistle. Anyone can hear a whistle at a great distance, much farther than a human voice. Signal mirrors and fires are appropriate for wilderness areas but in many cases Scouts camp near civilization. You can use a whistle also in wilderness areas to call for help to ground search teams.

Whistles let you make three types of signals, each with its own meaning. Three whistle blows indicate an emergency; two blows (not an emergency) is excellent for calling to others in your party; while one blow is a response to the other two calls to let the person know you heard them. By trading whistles the lost person can guide rescuers to themselves.

The best whistle type is one without an inside pea that will freeze or stick. A plastic whistle will prevent sticking lips to metal.

— *Perry Sisk, Dartmouth, N.S.*

Manitoba Jamboree

Manitobans will be pitching their tents at their Provincial Jamboree site beside the Vermillion River near Kelb, Manitoba, adjacent to Riding Mountain National Park this summer. "A Time For Spirits To Soar" will take place July 11 to 15, 1994. Events include: rappelling, a triathlon, tethered hot air ballooning, horseback riding, and much more.

For information or application forms contact the Manitoba Council at 883 Notre Dame Avenue, Winnipeg, Manitoba, R3E 0M4, Phone (204) 786-6661; FAX (204) 772-5248. Jamboree fee for youth and leaders is \$94.00. Hurry to sign up!

Prince Edward Island Jamboree

From July 9 to 16, 1994 Scouts from P.E.I. will hold their 5th Jamboree (PJ'94) at Camp Buchan on 60 acres of prime coastal land. The camp boasts a 500 metre sandy shoreline on Northumberland Strait. Special activities include: water sports, canoeing, and low tide exploring of the shoreline and tidal flats.

For more information contact Scout Headquarters in Charlottetown, P.E.I., Box 533, C1A 7L1, phone (902) 566-9153, FAX (902) 628-6936. Cost: \$135.00 plus food per participant. All are welcome! ^

\$1.50 Profit on EACH Bar!

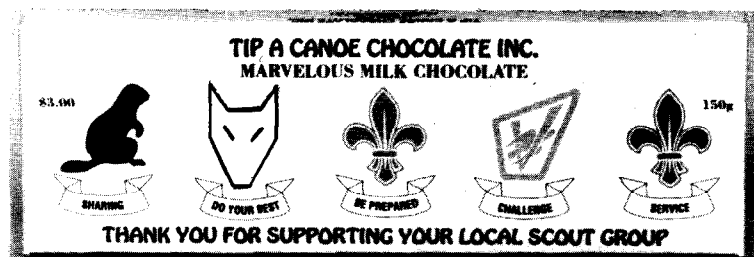

Made of creamy smooth milk chocolate, each 150 gm bar sells itself for \$3.00 and makes your group \$1.50 in profit. Tip A Canoe will pay the shipping costs on all orders 40 cases (24 bars per case) or more! All orders of less than 40 cases will be subject to a shipping charge of \$2.00 per case. Decide what your group's fund raising requirements are and order today!

Please fill out the order form below and mail it to:

Tip A Canoe Chocolates

2-6923 Farrell Rd. S.E.
Calgary Alberta
T2H 0T3

To Order Your Free Sample Please Call

1-800-465-2598

Many thanks to the 150th Sherwood Park Group in Alberta who ordered 50 cases and then turned around and ordered 40 more. Good luck to all the rest from 2nd East Whalley Gilford in Surrey, BC; to the 2nd Dunnville Ontario; to 1st St. Anthony, Newfoundland and all in between.